

YSI Incorporated

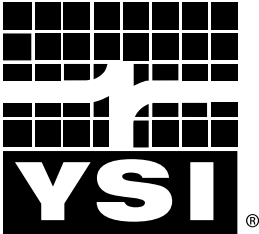

5400 & 5500D-01, 5500D-02, 5500D-04
MultiDO
Monitor, Control, & Alarm Instruments
User Manual

Item # 605877
 Rev F
 Drawing # A605877
 May 2015
 Copyright
 ©2015 YSI Incorporated.

Manufacturer:
 YSI, Incorporated
 A Xylem Brand
 1700/1725 Brannum Lane
 Yellow Springs, OH 45387 USA
 937-767-7241 www.ysi.com

All trademarks herein are
 registered to YSI Incorporated
 unless otherwise noted.

Teflon is a trademark of DuPont.
 Microsoft and Windows are registered trademarks of the Microsoft
 Corporation in the United States and other countries.
 Pentium is a registered trademark of Intel Corporation.

Table of Contents

1 Introduction 9
 Introduction 10
 Product Description 11
 Preview of User Manual 12
 Product Specifications 13
 Environmental Specifications 14
 Input System Specifications 14
 Component and System (non input) Specifications 16

2 Safety 19
 THIS IS IMPORTANT 20
 Warnings and Cautions 20
 Warnings 21
 Cautions 23

3 Installation & Wiring 25
 Hardware Installation 26
 Step 1 Install 5X00 27
 Location Considerations 27
 Mount the 5X00 28
 Surface Mount 28
 Rail Mount 29
 Panel Mount 29
 Install the Weather Shield 33
 Step 2 Locate and Install Sensor(s) 34
 Location Considerations 35
 YSI 5420 and YSI 5421 (Galvanic) probe assemblies 37
 YSI 626250 ODO (Optical Dissolved Oxygen) sensor 37
 Install Temperature Sensors 38
 Wiring Information 39
 PCBs 39
 5X00 Bulkhead Fittings 40
 Accessing the I/O Board 40
 Open Front Panel to Access I/O Board 41
 Close Front Panel 41
 Control Board 42
 Step 3 Ground 5X00 43
 Directions to Ground 5X00 44
 Step 4 Wire Power 45
 Wire AC Power 45

Table of Contents

Directions to Wire AC Power	45
Wire DC Power and Backup Power	46
Directions to Wire DC Power/DC Backup Power	47
Step 5 Wire Sensor(s).....	49
Wire DO Sensors	49
Directions to Wire DO Sensor(s)	49
Wire Temperature Sensor(s)	52
Directions to Wire Temperature Sensor(s)	53
Step 6 Wire Relay outputs	54
Directions to Wire Relay Outputs	54
Wiring a Contactor	55
Step 7 Wire Aux Inputs (Non Temperature)	56
Directions to Wire Aux Inputs (Non Temperature Inputs)	57
Step 8 Wire Network	60
Directions to Wire Network.....	61
Step 9 Wire and Install Communication Equipment.....	66
Email Alarming	66
RS232 Communication	66
Ethernet (TCP/IP) Module Communication	68
Step 10 Install and Wire IOEM/REM instruments	68
Lightning and Surge Protection.....	68
Sealants, Desiccants, and Securing 5X00.....	69
4 Configuring 5X00 Systems	71
5X00 Configuration and Monitoring	72
Front Panel Keys	73
Softkeys	73
Run Screen	75
Run Screen Icons.....	76
Menus	78
Submenu Screen Types	80
Main Menu	81
Calibration Menu	81
Getting Ready to Calibrate.....	82
Calibration Log	83
DO	83
Directions to Calibrate DO Sensor %Sat.....	83
Directions to Calibrate DO Sensor mg/L	84
Local vs Remote Instruments	86
System Menu	86
Adjust Contrast.....	87
Buzzer	88
BackLighting Timer.....	89

Table of Contents

Communication	89
Email Alarming.....	90
Ethernet.....	92
Node Network.....	97
Send Test Email Msg.....	99
Email Retry Delay.....	100
Force Serial Port.....	101
Non-Networked (Stand Alone) 5X00s	101
Configure AUX	102
Probe Name	102
Input Type.....	103
Configure E-AUX.....	108
Probe Name	109
Instrument.....	110
Channel	111
Input Type.....	111
Data Logging	117
Data Logging	118
Event Logging	120
Date/Time	122
Display Settings	123
ODO Cal K (5500D-01, 5500D-02 and 5500D-04)	124
Downloader/Updating 5X00 Firmware	126
Firmware Updater Directions.....	127
Force Downloader	130
General Alarm	131
Alarm Hold Off.....	132
Relay	132
Name Devices/Sensors.....	134
Password	137
Power Fail Menu	138
Serial Number	139
Service	140
Reset Clean Probes	140
Reset To Factory	141
Output Test	144
Service Hold	147
Version	148
AquaManager and the System Menu	149
Sensor Setup	150
Control Mode.....	152
Set Point Control	153
Timed versus Normal (non timed) Control.....	157

Validation Error and Autofix - Set Point Control Only	157
PID/PWM and PID 4/20mA Control mode	159
Aux and E-Aux Relay Digital	164
Aux and E-Aux Analog (0-1VDC, 0-5VDC and 4/20mA)	166
Temperature	168
DO 1-4	173
Salinity & Temp Compensation for DO Measurements	173
Two Range Controls for DO	173
Configure DO Systems	174
E-Aux system Offline	177
Configure sensor system as a 4/20mA output	178
AquaManager and the Sensor Setup Menu	179
Timers	180
Timers 1-4	180
Directions to Configure Timers 1 - 4	180
Feed Smart™ Timers 1-4	182
Feed Mode	184
Daily Weight	185
Daily Feedings	185
FCR	186
Sensors	187
Calibrate	189
AquaManager and the Timer Menu	190
Control Menu	192
Msg's Menu	193
Calibration Logs	194
Event Logs	194
Sensor Logs	195
Svr Hold softkey Button	196
5 AquaManager	197
Installing AquaManager	198
PC requirements and features	198
Software Installation	199
AquaManager Windows	200
Explorer Window	200
Node (Graph) Window	202
Systems Management	203
Database Management	204
Autopoller	204
Mapping	205
AquaManager Alarm Emails	206

6 Maintenance	207
Maintenance	208
Probe Maintenance at the Deployment Site	208
Algae and Debris	208
Calibration Checks	209
Recommended Quality Assurance Protocol	209
Alternative Quality Assurance Protocol (quick check and adjustment)	210
Sensor Care and Maintenance	211
DO Sensor	211
YSI 626250 sensor maintenance	211
YSI 5422 Electrode Maintenance	212
YSI 5420 and 5421 Sensor Maintenance	213
Recommended Cleaning of the 5X00 and Accessories	215
Storage	215
Short Term Storage	215
Long Term Storage 5420, 5421 and 5422	215
Long Term Storage 626250	216
Sensor Replacement	216
Charging DC batteries	216
AquaManager Database Maintenance	216
Replacement Parts & Accessories	216
Appendices	217
Appendix 1 - Unpacking and Inspection	218
Appendix 2 - Troubleshooting	219
Sensor Troubleshooting	219
Relay (Outputs) Troubleshooting	220
Email Alarm Troubleshooting	221
Network Troubleshooting	222
5X00 Systems Troubleshooting	223
Firmware Updater Troubleshooting	223
Feed Timer Troubleshooting	224
AquaManager Troubleshooting	224
Appendix 3 - Menu Maps	225
Menu Map Key	226
Appendix 4 - Declaration of Conformity	248
FCC Required Notice	251
Appendix 5 Parts and Accessories	252
Appendix 6 - SMS messaging	255
Appendix 7 - Alpha "A" curve	256
Appendix 8 - Warranty	257

Table of Contents

Appendix 9 - Contact Us.....258
 Ordering and Technical Support258
 Service Information258
Appendix 10 - Recycling.....259
 Recycling259
 Battery Disposal.....259

Index 260

1

Introduction

-5400/5500 Product Description
-User Manual Guide
-Specifications

Introduction

Thank you for purchasing a YSI 5X00 instrument. Throughout this manual YSI “5X00” is used globally to refer to YSI 5400, 5500D-01, 5500D-02 and 5500D-04 instruments. YSI 5X00s are fully programmable aquatic control and alarm instruments. A key feature of all 5X00 instruments is the ability to independently operate four dissolved oxygen (DO) inputs, six auxiliary (Aux) inputs and 8 E-Aux systems. (E-Aux systems require using an optional IOEM.). This allows control of multiple water systems from one instrument. Peripheral devices wired to the instrument respond to user-defined configurations to ensure that stable water conditions are maintained. The instruments’ on-site and remote access capability are suitable for a variety of applications.

5X00 features:

- four (4) independent DO systems;
- six (6) independent Aux I/O systems - [digital, analog (0-1VDC, 0-5VDC, 4-20mA). In addition four (4) of the six Aux I/O systems can be used as temperature systems.];
- eight (8) E-Aux input systems. E-Aux systems are used to monitor, control and alarm inputs wired to an optional IOEM
- eight (8) onboard relays - 240VAC@5AMPs; 110VAC@10AMPs;
- universal AC power with power fail alarm (only available on AC instruments);
- optional DC power with low battery alarm;
- four (4) ten event daily timers;
- four (4) feed timers;
- two (2) 32-bit processors;
- non-volatile memory of sensor, event, calibration, and configuration* data logs;
- 2000 data set memory for sensor data;
- field upgradable software and firmware;
- backlit LCD with timer function - input and output data displayed continuously;
- menu-driven programming with four (4) softkeys;
- networking capability - ability to connect a total of 32 5X00s, 5200As, IOEMs and REMs on one network via RS485 protocol;
- networked instruments can utilize another instruments output for a local system control or alarm;
- IOEM inputs and outputs can be used for a variety of uses - see IOEM/REM Installation and Safety Guide;
- optional AquaManager® PC software** serves as monitor management tool via direct (RS232) or TCP/IP connection. (AquaManager is required to configure IOEM instruments on a network.);

NEW

- email alarming via TCP/IP from instrument and/or AquaManager (local or TCP/IP) connection;
- NEMA 4X, IP65 enclosure;

See Product Specifications - page 13 for complete details on all 5X00 features.

*A configuration log records any changes made to the 5X00 setup. For example, changing a set point for an alarm would be recorded in the configuration log.

**AquaManager displays near real time data from 5X00 instruments and provides data logging, graphing, autopolling, mapping, and system configuration control from a PC. AquaManager is a valuable tool for remote and local access applications.

Product Description

The 5X00 system manages aquatic environments by automating control and alarm devices to maintain stable water conditions.

A 5X00 system is configured by the user. Therefore, each system setup is unique to the application. An example of a 5X00 system could include*:

- 5X00 instrument(s);
- 5X00 components such as power, communication, and network devices;
- *input peripheral devices (i.e. float switch, probe assembly);
- *output peripheral devices (i.e. aerator);
- 5X00 user-defined configuration;
- AquaManager PC interface (optional);

*Not all of the above items are included with the purchase of a 5X00 instrument.

Input devices send data to the 5X00. This data is processed based on instrument configuration. For example, a DO sensor (input) reports a 5.4 mg/L value and relay #3 (output) is configured to activate an aerator when value is ≤ 5.5 mg/L. The aerator wired to relay #3 will energize until the 5X00 receives a DO sensor reading \geq set point value.

Figure 1.1 shows the 5X00 front panel and enclosure. The front panel includes an LCD which continuously displays enabled current system conditions. Front Panel Keys are used to navigate screens and program configurations. Compression fittings located at the bottom of the enclosure provide liquid-tight connections for wiring peripheral devices and instrument components.

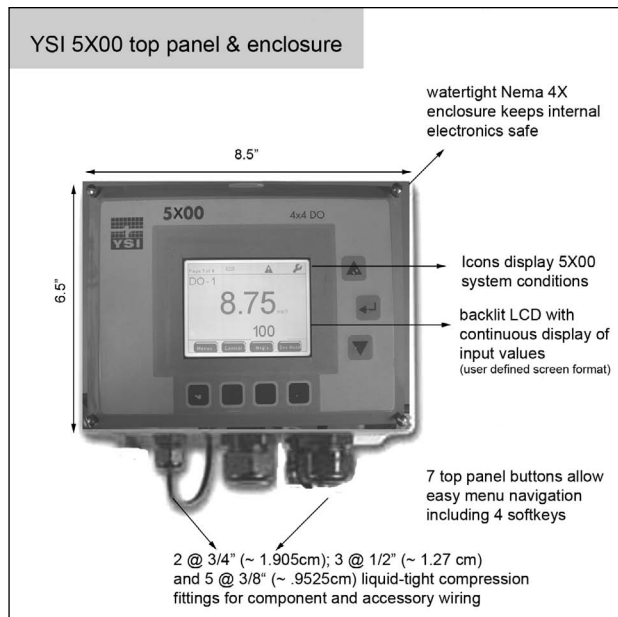

Figure 1.1

Preview of User Manual

This manual includes information on installing, configuring, operating, and maintaining a 5X00 system. YSI 5400, 5500D-01, 5500D-02 and 5500D-04 instruments have many similarities. Therefore “5X00” is used throughout this manual to refer to YSI 5400, 5500D-01, 5500D-02 and 5500D-04 instruments. 5500D-01, 5500D-02 and 5500D-04 at times are referred to collectively as 5500D instruments. Instructions, information and features specific to either YSI 5400 or YSI 5500D instruments will be referenced by using **5400** or **5500** in the left margin next to specific information.

Read Chapter 2 “*Safety Information*” starting on page 20 before installing or configuring a 5X00 system.

Chapter 3 “*Installation*” starting on page 26 provides information on how to install the 5X00, 5X00 components, and peripheral devices. Only *qualified* people should install a 5X00 system. Do not attempt to install or configure this device if you are not *qualified* to do so. If information is not clear, DO NOT PROCEED until clarification can be obtained. All wiring involving connections to main power must be performed by a qualified licensed electrician and must conform to all locally applicable electrical codes.

Chapter 4 “*Configuring 5X00 Systems*” starting on page 72 provides information on configuring 5X00 instruments.

Chapter 5 “*AquaManager*” starting on page 197 provides general information regarding the PC software program. The AquaManager program includes an extensive on-line help system which contains detailed information that is not provided in this manual.



This icon is used throughout the manual to indicate helpful information for AquaManager users.

NEW Is used to bring attention to new 5X00 instrument and AquaManager features and functionality.

Chapter 6 “*Maintenance*” starting on page 208 provides information on maintaining the 5X00 system including monitor and sensor service.

“Notes” at the end of each manual section provide additional information to help clarify certain 5X00 operations and features.

Appendices include information on Unpacking & Inspection, Troubleshooting, Menu Maps, Declaration of Conformity, Parts and Accessories, SMS Messaging, Warranty, Contact Us, Alpha “A” Curve and Recycling information.

An index is provided starting on page 260.

This is an interactive pdf file. Page numbers provided throughout the manual are linkable. Hover mouse over page number and click mouse to go to link.

Product Specifications

To ensure accurate and reliable performance, operate the 5X00 system according to the specifications provided in the following tables. Damage and/or incorrect operation could result if these specifications are not followed.

Product specifications are subject to change without notice. Visit www.ysi.com to view the most recent product specifications.

Environmental Specifications

Environmental Category	Operating Range
Temperature	-15 to 70°C (5 to 158°F)
Enclosure Rating	NEMA 4X (direct exposure to outside conditions) IP65
Compression Fitting Rating	IP 68/NEMA 6 (liquid tight)
Electrical Safety	IEC compliant*
Other	RoHS compliant

See Appendix 4 Declaration of Conformity - 248.

Input System Specifications

Aux Systems	There are 6 Aux input systems that allow digital or analog (0-1.0VDC, 0-5.0VDC, or 4-20mA) configuration. In addition, four of the Aux systems can be configured as temperature systems see <i>Temperature Systems Specs</i> - 15.
-------------	--

Aux System Type	Digital	Analog
Range	dry contact open/close	0 -1.0 VDC, 0-5.0 VDC, or 4-20mA
Accuracy	n/a	0-1.0VDC: $\pm 3\% \pm 10$ mV 0-5.0VDC: $\pm 3\% \pm 15$ mV 4-20 mA: $\pm 3\% \pm 100\mu$ A
Resolution	n/a	user selectable (0), (0.0), or (0.00)

DO Systems	There are up to 4 independent DO systems. Each DO system has 2 control \uparrow ranges, 2 control \downarrow ranges, and high and low alarming.
------------	---

Sensor Type 5400	Galvanic (mV)
Membrane Type	Teflon (TE), 2 mil (gray)
Range	0 to 500% air saturation 0 to 60 mg/L
Accuracy	$\pm 2\%$ or ± 0.2 mg/L, whichever is greater for 0-200% $\pm 6\%$ of reading for 200-500%
Resolution	0.1% (0.0-99.9%); 1% (> 99.9) 0.01 mg/L (0-10 mg/L); 0.1 mg/L (10-60 mg/L)

Response Time	95% of reading in 36 seconds for 2.0 mil Teflon membrane.
Cable lengths	4, 10, 20 m (special order up to 100m)
Flow requirements	6 inches per second or 15.24 cm/second for 2.0 mil Teflon membrane
Other	manual salinity compensation for DO mg/L readings

Sensor Type 5500D-01, 5500D-02, 5500D-04	Optical Dissolved Oxygen (dynamic luminescence quenching lifetime detection)
Dimensions	19 cm length (7.5 in); 2.4 cm diameter (0.95 in)
Membrane Type	Sensor Cap includes calibration coefficients
Range	0-500% air saturation 0 to 50 mg/L
Accuracy	$\pm 0.2^\circ$ C
Salinity Input Range	0-50 ppt
Storage Temperature	-20 to 70°C
Operating Temperature	-5 to 70°C
Response Time	90% in 25 seconds; 95% in 45 seconds
Cable lengths	1- 4- 10- 20- 30- 40- 50- 60- and 100-m; (3.3, 13.1, 32.8, 65.6, 98, 131, 164, 197 and 328 ft)
Flow requirements	None

Temperature Systems	There are 4 independent temperature systems. Auxiliary inputs 3, 4, 5, & 6 can be configured as temperature systems. Each temperature system has 1 control \uparrow range, 1 control \downarrow range, and high and low alarming. Temperature systems can be configured as the temperature source for DO measurements on a 5400 or as stand alone systems on either 5400 or 5500 instruments..
Sensor type	10,000 ohm @ 25°C thermistor
Range	0-45°C; 32-113°F
Accuracy	$\pm 0.2^\circ$ C
Resolution	0.1°C

Component and System (non input) Specifications

Hardware System	System Feature	Specification
Display/LEDs	backlit graphic LCD (320X240) with timer	readings updated 2 times a second
	diagnostic troubleshooting LEDs	
Outputs	8 on-board relays	240VAC@ 5AMPS switching capacity; 110VAC@10AMPS; type: SPDT
Electronics	ARM7 embedded microprocessor	
	DSP (digital signal processing)	Digital processing of 5X00 information ensures accurate and repeatable readings
Power: There are two 5X00 versions available. The DC version can only be powered by DC power. The AC version can be powered by AC or DC power.		
Power for DC Version:	external 12VDC power source	9-16.5VDC; 800 mA
Power for AC Version:	internal AC switching power supply	100-240VAC; 50-60Hz; 300 mA
Both AC and DC versions:	lithium battery (for real time clock)	2032 lithium ion
Firmware System	Firmware Feature	Specification
Timer Systems	4 timers	10 daily events per timer system
	4 feed timers	includes sensor & FCR control
	Flash Memory	Firmware field upgradable with local PC connection
	Data Logging	non-volatile data log memory
		storage of 4750 records
		sensor log (2000 records)
		event log (1250 records)
		calibration log (500 records)
		Configuration log (1000 records)
		Security
	Data filtering	reads 2-3 times per second; readings are averaged

Communication	Feature	Specification
	RS232	up to 100 ft (30m)
OR	Optional serial to ethernet device	remote TCP/IP PC access and/or email alarming
Instrument to Instrument Networking	Feature	Specification
	Network 2 to 32 isolated 5X00 and/or 5200A instruments	RS485 up to 4000 ft (1220m) entire network distance
AquaManager	Feature	Other PC Requirements
	Runs on Windows 2000/XP/Vista/Windows 7 operating systems 32-bit and 64-bit	PC capable of running Windows 2000 VGA display card CD-ROM Drive Total RAM Installed 16 Megs or greater 100 MB free hard-disk space

This page left intentionally blank.

2 Safety

-IMPORTANT safety information. Read this chapter before installing 5X00 components and peripheral devices.

THIS IS IMPORTANT

Take time to be safe when working on electrical circuits and equipment. It could save your life. Avoid unsafe acts and conditions. Do not operate or install the 5X00 before reading this chapter. Installing the 5X00 involves wiring high voltage equipment. Follow all provided safety information. Installation must be performed by someone who understand the dangers of, and is qualified to, wire electrical devices. If information or instructions are not clear, DO NOT PROCEED until clarification can be obtained.

ALWAYS:

Follow basic safety rules when working with or near high voltage circuits. The 5X00 is a high voltage instrument using 110v. Peripheral devices may also be high voltage devices.

Consider the result of each act. Keep away from live circuits. Do not change parts or make adjustments inside the equipment with high voltages on.

Do not service alone.



Do not tamper with interlocks. Safety devices such as interlocks, overload relays, and fuses should never be altered or disconnected except for replacement. Safety protection devices should never be changed or modified without a clear understanding of what effect the modification will have on the system.

Do not ground yourself.



Do not energize equipment if there is any evidence of water leakage.

Warnings and Cautions

Safety information is presented in this manual in one of two ways:

-  - WARNING - RISK OF ELECTRIC SHOCK This symbol identifies installation and operation procedures that can result in personal injury or death if safety information is not followed.
-  - AVERTISSEMENT – RISQUE DE CHOC ÉLECTRIQUE. Ce symbole identifie les procédures d'installation et d'opération pouvant entraîner des blessures ou la mort si les consignes de sécurité ne sont pas suivies.

-  - CAUTION - RISK OF DANGER This symbol identifies installation and operation procedures that can result in personal injury or damage to equipment if safety information is not followed.

These symbols () () appear in the left margin of the page to highlight safety information as it applies to a particular installation or operation step.

A complete list of all safety cautions is provided below. Warnings are provided in both English and French.

Install and use the 5X00 only in accordance with information documented in this manual.

Warnings

WARNINGS are used when personal injury or death can result when safety information is not followed.

-  WARNING: All wiring involving connections to mains power must be performed by a qualified licensed electrician, and must conform to all locally applicable electrical codes.

-  AVERTISSEMENT: tous les câblages comportant une connexion à l'alimentation secteur doivent être réalisés par un électricien qualifié et doivent être conformes aux codes électriques applicables.

-  WARNING: Do not make connections while power is applied. Turn off power and assure power "Lockout" before installing or servicing to avoid contact with electrically powered circuits. This includes working on devices connected to the relay outputs and auxiliary input systems. **Disconnect external power to the 5X00 before connecting or disconnecting components and/or peripheral devices.**

-  AVERTISSEMENT : n'effectuez aucune connexion alors que le circuit est sous tension. Coupez l'alimentation et assurez l'interdiction du courant avant toute installation ou tâche d'entretien afin d'éviter d'entrer en contact avec des circuits sous tension. Cela comprend tout travail sur des appareils connectés à des sorties de relais et des systèmes d'entrée auxiliaires. **Déconnectez l'alimentation externe du modèle 5X00 avant de connecter ou de déconnecter des composants et/ou des appareils périphériques.**

 **WARNING:** A switch or circuit breaker shall be included in the building where the 5X00 is installed. The disconnecting device should be in close proximity to the equipment and within easy reach of the operator. The disconnecting device shall be marked for the equipment.

 **AVERTISSEMENT :** un commutateur ou disjoncteur doit être installé dans le bâtiment où le modèle 5X00 est installé. Le dispositif de déconnexion doit se trouver à proximité de l'équipement et à portée de l'opérateur. Le dispositif de déconnexion doit indiquer l'équipement auquel il se rapporte.

 **WARNING:** The covers of fuse boxes and junction boxes should be kept securely closed except when service is being done.

 **AVERTISSEMENT :** le couvercle des boîtes à fusibles et des boîtes de dérivation doit être maintenu fermé sauf lors des tâches d'entretien.

 **WARNING:** Electric sparks and chemical exposure are potential dangers when working with batteries. Use necessary precautions and follow all manufacturer's directions.

 **AVERTISSEMENT :** l'exposition à des étincelles ou produits chimiques est un danger potentiel inhérent à tout travail sur des batteries. Observez les précautions nécessaires et suivez les consignes du fabricant.

 **WARNING:** Ground the 5X00. *See Ground 5X00 - page "Step 3 Ground 5X00" on page 43.* The sensitivity and stability of the 5X00 will be impaired if the 5X00 is not grounded. To avoid possible electrical shock or damage to the equipment, connect earth ground to the 5X00 I/O control board. In addition to grounding the 5X00, all tanks should be electrically grounded using a ground probe.

 **AVERTISSEMENT :** mettez le modèle 5X00 à la terre. Voir Mise à la terre du modèle 5X00. La sensibilité et la stabilité du modèle 5X00 seront affectées s'il n'est pas mis à la terre. Pour éviter toute possibilité de choc électrique ou d'endommagement de l'équipement, connectez le fil de terre à la carte d'E/S du modèle 5X00. En plus de la mise à la terre du modèle 5X00, tous les réservoirs doivent être mis à la terre.

 **WARNING:** Do not overload relays. Verify that the surge current at startup does not exceed the relay load ratings. Be familiar with all safety information regarding installing and servicing peripheral devices.

 **AVERTISSEMENT :** ne surchargez pas les relais. Vérifiez que la surtension de démarrage ne dépasse pas la capacité de charge nominale du relais. Prenez con-

naissance de toutes les consignes de sécurité concernant l'installation et l'entretien des appareils périphériques.

 **WARNING:** The 5X00 is not fused. Fuses used in any peripheral equipment should be removed and replaced only after the circuit has been de-energized. When a fuse blows, it should be replaced only with a fuse of the same current and voltage ratings. Circuits should be carefully checked before fuse replacement. A burned out fuse is often the result of circuit fault.

 **AVERTISSEMENT :** le modèle 5X00 ne contient pas de fusible. Les fusibles utilisés par les équipements périphériques doivent être retirés et remplacés uniquement après que le circuit a été mis hors tension. Lorsqu'un fusible est grillé, il doit être remplacé uniquement par un fusible d'une tension et d'un ampérage nominaux identiques. Les circuits doivent être soigneusement vérifiés avant le remplacement d'un fusible. Un fusible grillé est souvent le résultat d'une défaillance de circuit.

 **WARNING:** Do not apply power to the 5X00 until all electrical connections are verified and secured.

 **AVERTISSEMENT :** ne mettez pas le modèle 5X00 sous tension tant que les connexions électriques n'ont pas été vérifiées et sécurisées.

Cautions

 **CAUTIONS** are used when personal injury or damage to equipment can result if safety information is not followed.

 **CAUTION:** The 5X00 utilizes sensitive solid state devices that can be damaged by static shock. Installers must observe accepted ESD (Electro-Static Discharge) procedures while connecting wires to the 5X00 control board.

 **CAUTION:** Sensors are powered by the 5X00 instrument and use a "floating" ground reference. This requires that the probe not be individually grounded.

 **CAUTION:** Power supply voltage above 16.5 VDC may permanently damage the 5X00. *See Wire DC Power - 46.*

 **CAUTION:** Surge protectors are strongly recommended to protect from secondary surges and lightning. Surge suppression devices should be located on the AC line supplying power to the 5X00 and any signal lines connecting the 5X00. *See Lightning and Surge Protection - 68.*

CAUTION: It is essential that all sensor wiring be run in a separate cable or conduit from power wiring.

This page left intentionally blank.

3 Installation & Wiring

Installing & wiring 5X00 components and peripheral devices

Hardware Installation

Correctly install 5X00 system components to ensure accurate data collection and reliable operation. First, determine what monitor, control, and alarm functions the 5X00 system will perform. Because system components are wired to the 5X00 instrument, it is important to determine where and how components will be installed and configured. Preparing a system schematic (figure 3.1) is helpful.

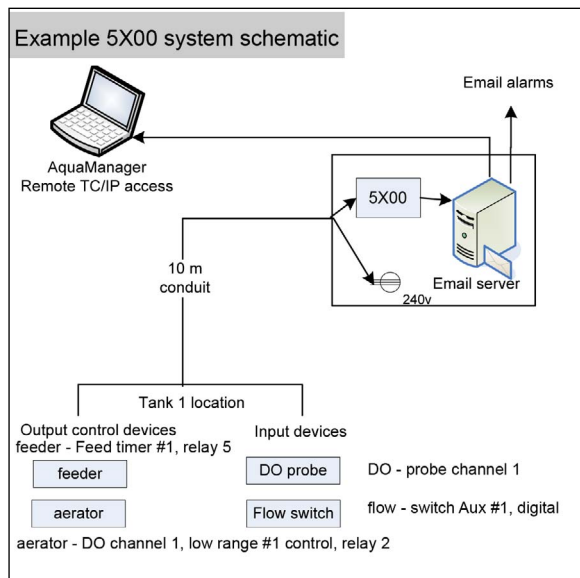

Figure 3.1

Hardware installation steps (not all steps required for all applications):

- Step 1 - install 5X00 instrument
- Step 2 - locate and install sensor(s)
- Step 3 - ground 5X00
- Step 4 - wire power
- Step 5 - wire sensors(s)
- Step 6 - wire relays (output devices)
- Step 7 - wire aux input devices (excluding temperature probes)
- Step 8 - wire a network of 2 - 32 instruments
- Step 9 - install and wire communication equipment
- Step 10 - install and wire OEM and REM instruments (optional). OEM/REM Installation information is included in a separate manual. See OEM/REM Installation and Safety Guide.

See *Chapter 4 Configuring 5X00 Systems* - starting on 72 for directions on programming 5X00 systems.

Tools and supplies needed for hardware installation:

- Phillips-head screwdriver to remove 5X00 front panel to access I/O board and lower board assembly
- necessary tools for cutting mounting holes in mounting brackets (rail mount) and/or control panel (panel mount)
- 5/32" Allen wrench (panel mount only)
- electric drill and bits for mounting 5X00 (panel or rail) and for drilling rubber grommets in bulkhead fittings
- small flat-head screwdriver to terminate wires on I/O board pluggable terminal strips
- wrench to tighten bulkhead fittings following system component wiring
- tweezers to replace the membrane gasket on the YSI 5422 sensor
- wire strippers
- distilled water for DO membrane installation
- contactors may be required for relay wiring; see *contactor wiring* - page 55 .

Optional accessories for hardware installation:

- surface mount hardware (included)
- rail mount hardware
- panel mount hardware
- weather shield hardware
- serial to ethernet device
- wiring for network wiring
- wiring not supplied with components and/or peripheral devices

Step 1 Install 5X00

Select a mounting location and method to mount the 5X00.

Location Considerations

The 5X00 must be located:

- above any level where water damage can occur
- away from extremely high or low temperature sources
- away from vibrating surfaces
- at least two 2 feet (~.7 m) from any high voltage conduit

- away from electromagnetic, radio, AC motor, transformer, or antennas
- so the front panel can be fully opened and serviced
- so system component wires are run as specified in this manual and according to local applicable electrical code

Mount the 5X00

Select surface, rail, or panel mount option. Install the weather shield for outdoor installations.

Surface Mount

Mount 5X00 to any flat surface using mounting brackets. Mounting brackets and screws are included with the 5X00.

1. Fasten the mounting brackets to the back of the 5X00 with the mounting screws - figure 3.2.
2. Tighten the screws, securing the brackets to the back of the 5X00 enclosure.
3. Fasten the 5X00 mounting brackets to the mounting surface with the mounting screws provided - figure 3.2. Make sure screws adequately secure 5X00 to surface.
4. Tighten the screws, securing the 5X00 to the surface.

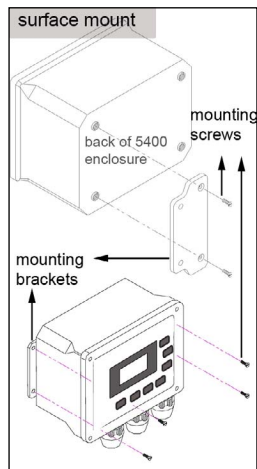

Figure 3.2

Rail Mount

Mount 5X00 to handrail or pipe 1 to 1.5" (2.5 to 3.8cm) in diameter. The rail mount kit (YSI model number 6509) includes u-bolts, a pre-drilled metal plate, washers, and nuts.

1. Drill holes in the mounting brackets to fit the u-bolts. Use the pre-drilled metal plate as a template.
2. Fasten the mounting brackets to the back of the 5X00 with the mounting screws as shown in figure 3.2.
3. Tighten the screws, securing the brackets to the 5X00.
4. Place the u-bolts around the rail securing the 5X00 to the pipe or rail by feeding through the pre-drilled holes on the mounting brackets as shown in figure 3.3.
5. Secure the metal plate over the u-bolts and around the rail or pipe using washers and nuts provided.
6. Tighten the screws, securing the 5X00 to the rail.

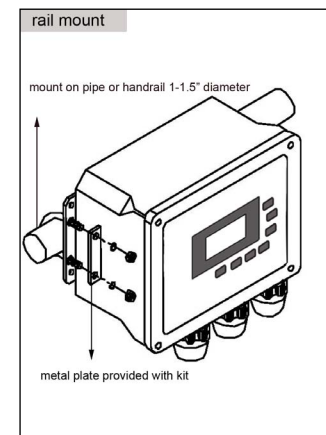



Figure 3.3

Panel Mount

Panel mount the 5X00 if the 5X00's front panel is to be mounted on a control panel or any vertical surface where only the front panel will be accessible from the mounting surface. The panel mount kit (YSI model number 6510) includes the standoffs and frame necessary to mount the 5X00 to any panel 9.5" l x 7.5" w (~24x19cm). The space behind the panel must be at least 5.5" (14cm) deep.

 **WARNING:** Disconnect external power to the unit before opening the front panel.

 **AVERTISSEMENT:** déconnectez l'alimentation externe de l'unité avant d'ouvrir le panneau avant.

1. See *Open Front Panel to Access I/O Board* - page 41 to remove front panel from enclosure.

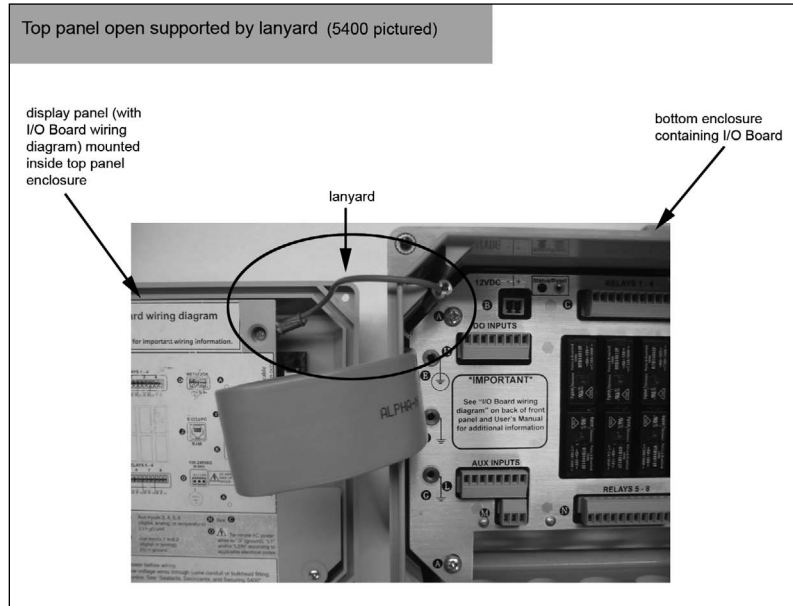

Figure 3.4

2. Disconnect front panel ribbon cable by pressing the two IDC header connectors located on the front panel out (away from the IDC header) - figure 3.5.

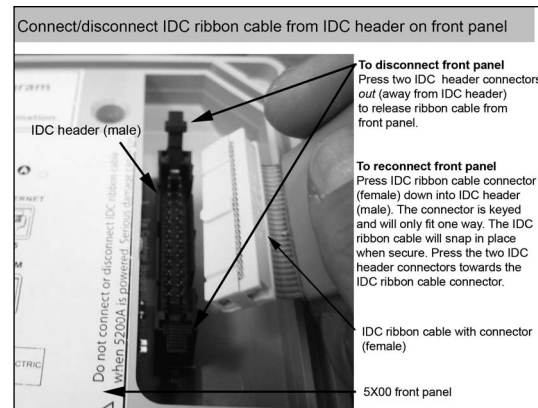

Figure 3.5

3. Remove and retain four screws that secure display board into top panel enclosure - figure 3.6. (Display board is mounted on panel attached to 5X00 top panel. I/O Board wiring diagram is located on the display board panel.)

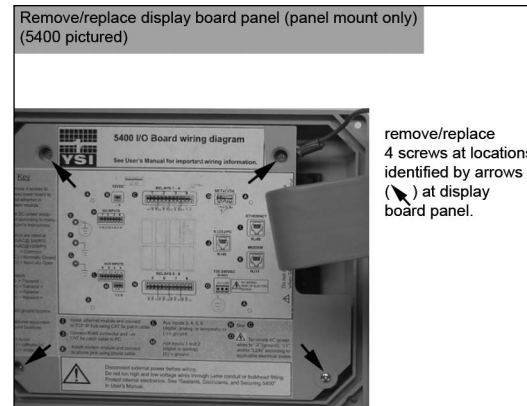

Figure 3.6

4. Carefully lift out the display board and remove the lanyard from the display board panel - figure 3.7. Set display board panel and top panel aside.

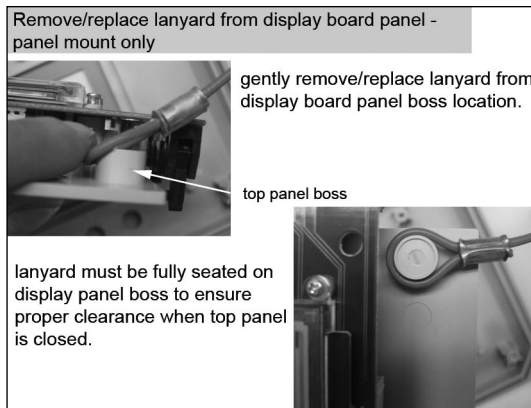

Figure 3.7

5. Fasten the mounting brackets to the back of the 5X00 enclosure with the mounting screws - figure 3.2 - page 28.
6. Tighten the screws, securing the brackets to the 5X00.
7. Drill hole in panel for 5X00 enclosure (dimensions provided with kit).
8. Place standoffs between 5X00 mounting brackets and panel surface - figure 3.8- page 32.
9. Secure 5X00 to panel with frame using washers and bolts provided.

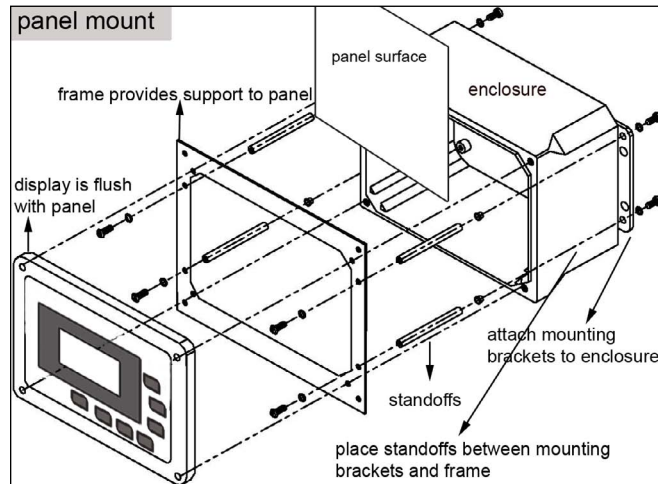

Figure 3.8

10. Reattach lanyard by placing lanyard at proper location of display board panel. Make sure lanyard is fully seated on display panel boss to ensure proper clearance when front panel is closed- figure 3.7.
11. Replace four screws to reattach display board panel to front panel enclosure - figure 3.6.
12. Connect 5X00 display board to ribbon cable - figure 3.5.
13. Secure the 5X00 front panel to the frame using mounting screws. Follow procedures provided at *Close Front Panel* - page 41 to secure 5X00 and protect internal electronics.
14. Tighten the screws, securing the 5X00 to the panel.

Install the Weather Shield

Install the weather shield for outdoor installations. The weather shield can be used with either a surface or rail mount. The weather shield kit (model number 6505) includes a weather shield, u-bolts, pre-drilled metal plate, washers, and nuts.

1. First complete steps 1-2 under Surface Mount or steps 1-3 under Rail Mount depending on the type of installation. Note: You may need to modify the pre-drilled holes in the weather shield depending on the mounting location.
2. At step 3 (surface mount) or step 4 (rail mount), attach the weather shield with the metal plate installed securely to the surface or rail. Figure 3.9 shows the weather shield installed for a rail mounted 5X00.
3. Tighten the screws, securing the weather shield.

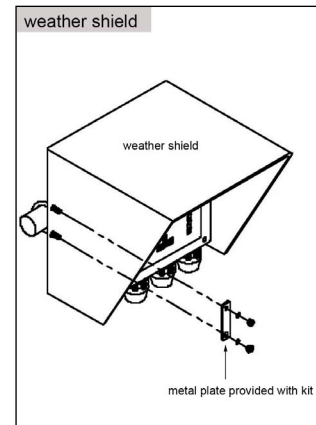

Figure 3.9

Step 2 Locate and Install Sensor(s)

Throughout the manual, the term “probe” refers to the end of the cable where the sensor is located and the term “sensor” refers to the sensing portion of the cable/probe assembly.

DO Sensors

5X00 instruments can be configured with 1, 2, 3, or 4 dissolved oxygen (DO) sensors depending on the model. (models 5400 and 5500D-04 can be configured with up to 4 DO probes; model 5500D-02 can be configured with up to 2 DO probes; model 5500D-01 can be configured with 1 DO probe.) Auxiliary (aux) inputs 3, 4, 5 and/or 6 can be configured as temperature inputs. YSI 5400 instruments use a YSI 5421-X DO (galvanic)/temperature, and/or a YSI 5420-X DO (galvanic) sensor assembly. YSI 5500 instruments use YSI 626250 ODO (Optical Dissolved Oxygen) sensors.

DO sensors for 5400 instruments require a properly installed membrane. The 5420 and 5421 galvanic sensors use a 2 mil Teflon membrane. ODO sensors for 5500 instruments require a sensing cap. 5500 instrument sensor caps are factory calibrated with sensor cap coefficients. It is important to retain sensor cap coefficients (provided by YSI) for the life of the sensor.

Temperature Sensors

Temperature sensor(s) must use a 10K thermistor (at 25°C). See *Appendix 6 Alpha A Curve* - page 256.

5400 Aux temperature sensors can be configured as the temperature source for DO systems on YSI 5400 instruments. Aux temperature sensor(s) cannot be configured as DO temperature sources on YSI 5500 instruments. YSI 5500 DO systems always use the temperature from the YSI ODO probe. For accurate DO measurements, ensure that the temperature reading for each DO channel is representative of the temperature at that DO sensor’s location. This is important when using the same temperature input source for multiple DO sensors. Example - if the temperature source for DO1 and DO2 is the temperature sensor connected to Aux 3 at the DO1 sensor location, it is important that the temperature at the DO2 sensor location is the same as at DO1 sensor location.

See *Chapter 4 Sensor Setup* - page 150, for information on configuring 5X00 sensor systems. User defined DO system configuration items include:

- Display format (i.e. units of measure. For example, mg/L or % saturation, °C or °F);
- Temperature source (5400 only);

- Salinity input value (user entered salinity value of the water being monitored);
- Elevation;
- Setpoint, control, and alarm values and ranges;
- Control and alarm relay assignments;

Location Considerations

Readings gathered at the sensor location(s) are data logged and processed by the 5X00 instrument. Output control and alarm devices are configured to respond to sensor values. Therefore, it is essential to have accurate readings at the sensor location. Locate sensors according to the below specifications.

5400 Locate sensor end of probe assembly:

- in a location that represents the entire system
- where the water flow is at least 6 inches per second (15.24 cm/sec) for 2.0 mil Teflon membrane
- in a location that is free from debris (e.g. algae); ideally at a 45° angle from vertical position and directed with the flow - figure 3.10

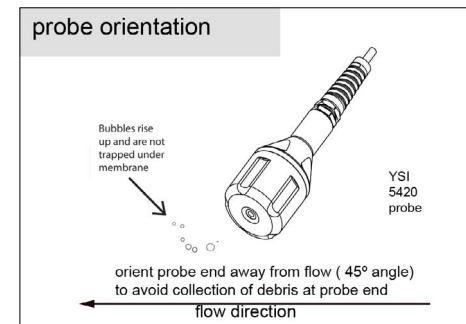

Figure 3.10

- in a well mixed, free-flowing area; midstream and mid-depth typically gives representative readings; the probe assembly and cable are fully submersible up to the cable connector
- submersed at all times so liquid level fluctuations do not expose the sensors to the atmosphere
- so the sensor/probe cabling is not routed near rotating machinery and/or equipment involving electrical switching or regulation
- so that the sensor assembly and cabling are located away from sources of electrical interference such as UV sterilizers, florescent lighting, ballasts, pumps, any high voltage peripheral devices, etc.

⚠ CAUTION: run high and low voltage cabling through separate bulkhead and conduit

- where regular maintenance, including calibration can easily be done. Calibrations are performed using the 5X00 front panel.

Note:

- If a 5420 or 5421 sensor requires replacement, the entire probe/cable assembly must to be replaced.

5500 Locate sensor end of probe assembly:

- **in a location that represents the entire system**
- Insert the probe into sample. Move the probe in the sample to release any air bubbles and to provide a fresh sample to the sensor cap. This movement is only necessary when first inserting the probe into the sample.
- Since the ProODO utilizes optical luminescent technology, continuous sample movement or stirring is not required. (Please note however that flow does increase response time of sensor.) The probe will fit into a 300 mL BOD bottle for taking initial and final BOD readings. For best results in a BOD bottle, a stirring device should be used to properly mix the sample and to keep solids from settling at the bottom.
- Allow the temperature readings to stabilize and wait approximately 25-35 seconds for the DO readings to stabilize.
- in a location that is free from debris (e.g. algae); ideally at a 45° angle from vertical position and directed with the flow.
- in a well mixed, free-flowing area; midstream and mid-depth typically gives representative readings; the probe assembly and cable are fully submersible up to the cable connector.
- submersed at all times so liquid level fluctuations do not expose the sensors to the atmosphere.
- so the sensor/probe cabling is not routed near rotating machinery and/or equipment involving electrical switching or regulation
- so that the sensor assembly and cabling are located away from sources of electrical interference such as UV sterilizers, florescent lighting, ballasts, pumps, any high voltage peripheral devices, etc.

⚠ CAUTION: run high and low voltage cabling through separate bulkhead and conduit

5400 YSI 5420 and YSI 5421 (Galvanic) probe assemblies

The YSI 5420 probe/cable assembly includes a galvanic DO sensor. The YSI 5421 includes a galvanic DO and temperature sensor. The DO sensor on both of these cables is shipped with a dry membrane. A new membrane with fresh electrolyte must be installed on the DO sensor prior to use. Complete instructions are provided with the sensor and membrane kit.

Figure 3.12 shows the external parts of the YSI 5420 probe/cable assembly.

After installing the probe in its monitoring location, see *Wire Sensors* - page 49 for wiring directions.

Probes should be serviced on a regular basis. See *DO Probe Maintenance* - page 211.

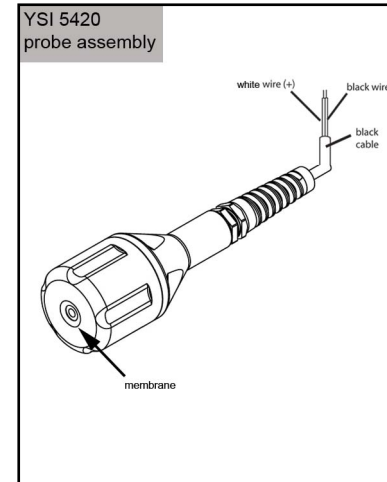

Figure 3.12

5500 YSI 626250 ODO (Optical Dissolved Oxygen) sensor

The YSI 626250 probe assembly includes an ODO sensor and sensor cap. Sensor cap refers to the removable sensing cap that is replaced about once per year (Figure 3.12a) YSI 626250 probe assembly includes a temperature sensor. An instruction sheet is included with replacement sensor caps. This instruction sheet is important because it includes the calibration coefficients for your sensor cap. After using this sheet for general probe setup, be sure to store it in a safe place in case you need to reload these calibration coefficients in the unlikely event that they are ever deleted from the probe.

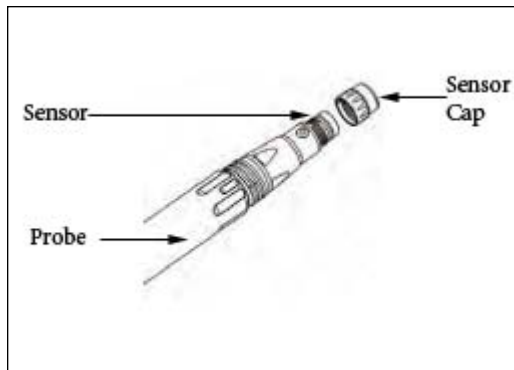

Figure 3.12a

Directions to prepare the ODO probe for the first time:

1. Remove the metal probe guard from the probe by turning it counterclockwise.
2. Remove the red storage cap which contains a moist sponge from the end of the probe by pulling it straight off the sensor. Save this to use later for long term storage.
3. Reinstall the probe guard by sliding it carefully over the sensor and then threading it onto the cable/probe assembly with a clock.
4. Calibrate probe - page 83.

Notes:

- A new cable/probe assembly already has a sensor cap installed and the sensor cap coefficients are preloaded into the probe at the factory.
- Perform ODO calibration whenever ODO caps are replaced see Calibration page 83.

Install Temperature Sensors

The 5X00 system will support 4 Temperature/Aux Analog inputs. Temperature sensors are included on YSI 5421 (galvanic) and 626250 sensor and/or sensor assemblies. Alternate temperature sensors can be used but must be thermistors with 10K at 25°C. See *Appendix 6 Alpha Curve* - page 256.

After installing the temperature sensor in its monitoring location, see *Wire Temperature Sensors* - page 52.

Probes should be serviced on a regular basis. See *Probe Maintenance* - page 211.

Wiring Information

System components must be wired correctly to ensure reliable performance and accurate data collection. Directions are provided on the following pages for wiring all components and peripheral devices.

PCBs

There are four printed circuit boards (PCBs) inside the 5X00 enclosure. They are:

- Display board (mounted in the front panel)
- I/O board is attached to a metal plate inside the enclosure and is visible when front panel is removed
- DO daughter board mounted to the I/O Board
- Control board (connected to the under side of the I/O Board)

Notes:

- I/O board and control board (including DO daughter board) are attached to a metal plate and are referred to as the “lower board assembly”. See *Control Board* - page 42.
- No 5X00 components or peripheral devices are wired to the display or DO daughter board.

Most components including: power, Aux input, network, relay output, and RS232 communication components are terminated on the I/O board. 5X00 ground wire and sensor ground wires (also called drain wires) are terminated to the metal plate that is attached to the lower board assembly. The optional serial to ethernet device is installed on the control board. The front panel must be removed when wiring 5X00 components and peripheral devices. See *Accessing the I/O Board* - page 40. It is recommended that some system configuration and testing be done in conjunction with hardware installation. This will ensure that the 5X00 system is wired correctly. Necessary configuration information (from Chapter 4 - “*Configuration*”) is referenced in the applicable test system procedure.



WARNING: Follow all safety information and local electrical codes when wiring 5X00 system components and peripheral devices. Proper wire gauge should be determined based on voltages and wire/cable length. Incorrect wiring can result in damage to you or equipment. Ground loops can also result due to improper wiring.



AVERTISSEMENT : suivez toutes les consignes de sécurité et les codes électriques en vigueur lors du câblage des composants du système 5X00 et des appareils périphériques. Le calibre correct des câbles doit être déterminé en fonction des tensions et de la longueur des câbles/fils. Un câblage incorrect peut entraîner des blessures et endommager l'équipement. Des boucles de mise à la terre peuvent également être provoquées par un câblage incorrect.

5X00 Bulkhead Fittings

Five bulkhead fittings [5 @ 3/8" (.9525cm), 2 @ 3/4" (1.905cm) and 3 @ 1/2" (1.27cm)] located at the bottom of the 5X00 enclosure provide watertight connections for 5X00 system component wiring. Rubber grommets must be "pushed out" of the compression fitting housing and drilled for wiring installation. The drill bit diameter should be slightly smaller than the wire diameter so that a watertight seal can be made. Rubber grommets can be frozen (put in a freezer for 1 hour) and then easily drilled to the required diameter. Some pre-drilled rubber grommets are supplied with the 5X00.

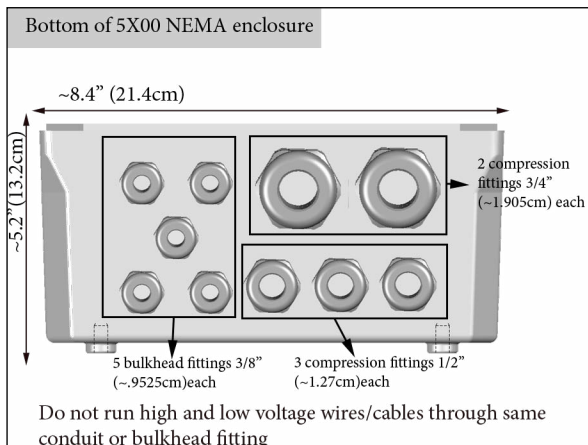

Figure 3.13

Accessing the I/O Board

The I/O board is accessible when the 5X00 front panel is removed. The letters on the metal plate, which is attached to the lower board assembly, identify ground wire termination locations and pluggable terminal strip locations on the I/O board. Letters on the metal plate correspond to the wiring diagram located on the inside of the top panel - figure 3.14. A ribbon cable connects the display board (mounted in the top panel) to the I/O board. When the 5X00 top panel is removed, a lanyard protects

against stress on the ribbon cable. See *Open Top Panel to Access I/O Board* - page 41.

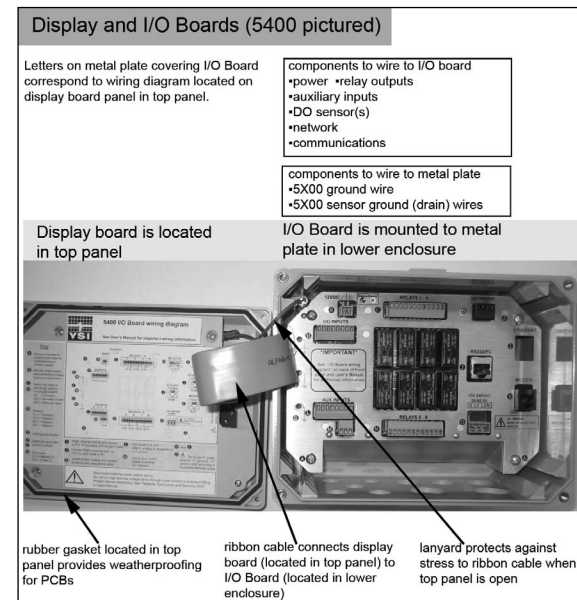

Figure 3.14

Open Front Panel to Access I/O Board



WARNING: Disconnect external power to the unit before doing any wiring.



AVERTISSEMENT : déconnectez l'alimentation externe de l'unité avant d'effectuer un câblage quelconque.

1. Loosen the 4 mounting screws connecting the front panel to back enclosure. Captive screws remain in front panel after loosening.
2. Carefully lift the 5X00 front panel from the back enclosure. The front panel should be placed to the left of enclosure. Allow the lanyard to hold the weight of the front panel. The rubber gasket seated in the front panel should remain in the front panel lid.

Close Front Panel

1. Verify all installed components and peripheral equipment have secure connections and that there are no bare wires that could cause a short inside the enclosure.

2. Tighten bulkhead fittings after connecting all 5X00 wiring. (Hand tighten fittings around rubber grommet. Tighten bulkhead fittings into 5X00 enclosure with wrench being careful to not overtighten.)
3. Follow information in *Sealants, Desiccants and Securing the Monitor Section* - page 69 to safeguard against damage to internal electronic components.
4. Make certain the gasket in front panel lid is in place and not twisted or damaged.
5. Replace front panel making sure that ribbon cable is not trapped in the gasket channel before inserting mounting screws.
6. Tighten mounting screws, making sure not to cross thread. The screws are stainless steel, and the receiving threads are brass. Do not over-tighten!



WARNING: The 5X00 utilizes sensitive solid-state devices that can be damaged by static shock. Installers must observe accepted ESD (Electro-Static Discharge) procedures while connecting cabling to the 5X00 I/O plate or to any other internal component or damage may result.



AVERTISSEMENT : le modèle 5X00 utilise des appareils transistorisés sensibles pouvant être endommagés par des décharges d'électricité statique. Les installateurs doivent observer les procédures de protection acceptées contre les décharges électrostatiques lors du câblage à la carte d'E/S du modèle 5X00 ou à tout autre composant interne afin d'éviter tout risque de dommage.

Control Board

The control board is mounted underneath the I/O Board. The serial to ethernet device and lithium battery are installed on the control board. Complete installation instructions, including accessing control board, are provided with the optional serial to ethernet device. Figure 3.15 shows the control board and I/O Board removed from the 5X00 enclosure.

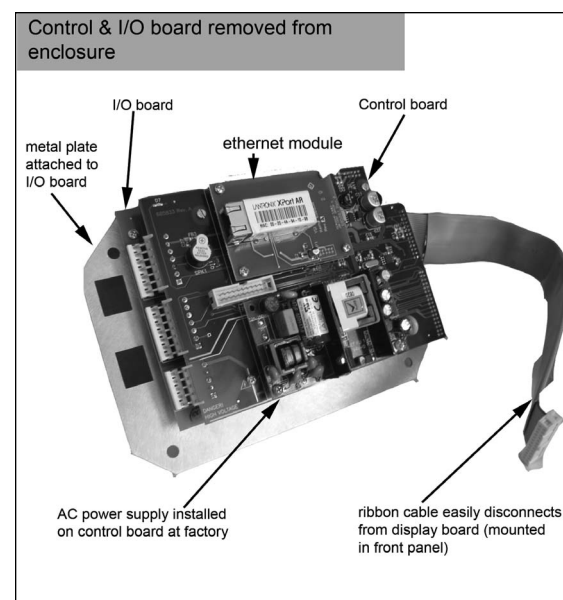

Figure 3.15

Step 3 Ground 5X00



WARNING: Ground the 5X00 to avoid possible electrical shock or damage to the equipment.



AVERTISSEMENT : mettez le modèle 5X00 à la terre afin d'éviter tout risque de choc électrique ou d'endommagement de l'équipement.

Ground the 5X00 at location G on the metal plate. The metal plate is attached to the lower board assembly. Use locations E and F to ground the DO sensor ground/drain wires - figure 3.16. (Common lettering references are used for both 5400 and 5500 models). Titanium ground rods can also be used to ground peripheral equipment.

In addition to grounding the 5X00, all tanks should be electrically grounded via a ground probe.

Directions to Ground 5X00



WARNING: Disconnect external power to the unit before wiring.



AVERTISSEMENT : déconnectez l'alimentation externe de l'unité avant d'effectuer un câblage quelconque.

1. Perform steps 1 - 2 of 5X00 installation.
2. Open front panel - page 41.
3. Remove screw from location **F** or **G**.
4. Feed ground wire through drilled hole in rubber grommet and to location **F** or **G** on metal plate covering I/O Board. Ground wire gauge must conform to all locally applicable electrical codes.



CAUTION: Run high and low voltage cables through separate bulkhead and conduit.

5. Install a ring (eyelet) or spade (fork) terminal onto the ground bare wire before terminating ground wire to F or G.
6. Return screw at **F** or **G** over terminal connection of ground wire.

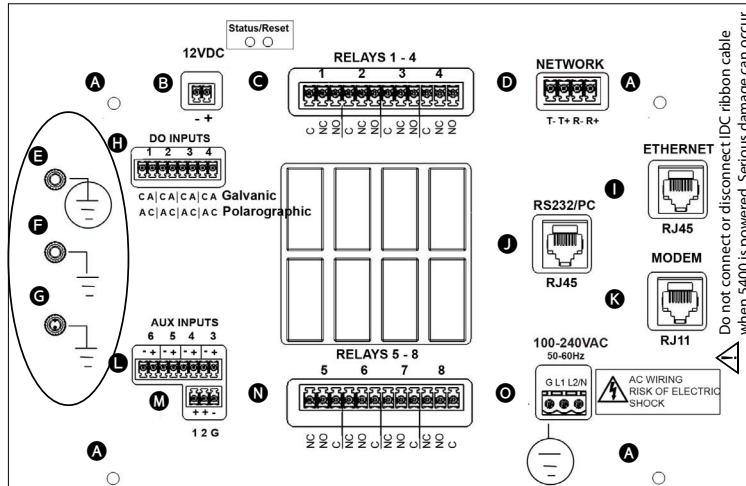

Figure 3.16

7. Terminate other end of the earth ground wire to a cold water pipe, steel rod, copper pipe, or earth ground.
8. Complete other wiring to configure 5X00 system.
9. Close front panel - page 41.

Step 4 Wire Power

5X00 instruments are available with either AC or DC power. The DC version can only be powered by DC power. The AC version can be powered by either AC or DC. If an AC version is properly wired and configured for AC and DC backup, and AC power fails, the instrument will be powered by the DC backup which supplies backup power. If DC voltage drops below a user defined safe operating range, an alarm occurs.



CAUTION: At 120VAC, the 5X00 draws 25 watts (~0.2 amps). Use wiring suitable for that load following all safety information and local electrical codes.

Back up power is recommended when operating with AC power. Backup power can be supplied by 12VDC or UPS battery source.

Wire AC Power

The AC power option includes an integrated universal (worldwide) AC switching power supply allowing AC power from any AC receptacle 100-240VAC. AC power wires are terminated at location **O** on I/O Board - Figure 3.17. (Common lettering references are used for both 5400 and 5500 models).

Directions to Wire AC Power



WARNING: Disconnect external power to the unit before wiring.



AVERTISSEMENT : déconnectez l'alimentation externe de l'unité avant d'effectuer un câblage quelconque.

1. Perform steps 1-3 of 5X00 installation.
2. Open front panel - page 41.
3. Feed AC power cable through drilled hole in rubber grommet to location **O**. The terminal strip is removable.



CAUTION: Run high and low voltage cables through separate bulkhead and conduit.

4. Terminate AC power wires to pins "G" (ground), "L1", and/or "L2/N" according to applicable local electrical codes. Use minimum 18 gauge 3 wire power cord.



CAUTION: It is recommended to power only the 5X00 instrument with the power cord to prevent exceeding the current draw of the AC power supply.

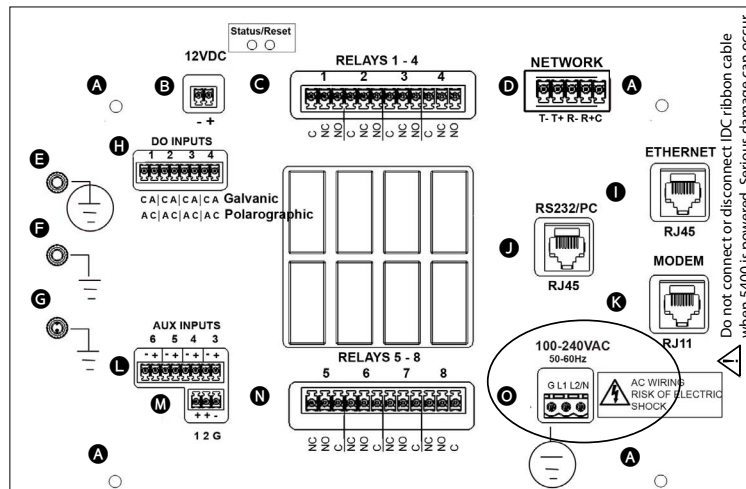

Figure 3.17

5. Complete other wiring to 5X00.
6. Close front panel - page 41.
7. Test AC power.

Test AC Power

Turn on main power. The enabled system values display on the Run Screen after initial YSI splash screen. If applicable, install and configure DC power backup 46. Verify AC power at the **Menus → System → Version** menu - page 148.

See *power fail menu* - page 138 for AC power event log information.

Wire DC Power and Backup Power

The 5X00 may be powered by most regulated 9.0-16.5 VDC sources that provide 800mA of current and are isolated from mains supply by double or reinforced insulation. The DC backup power source is user supplied and could be lead acid, gel cell, or UPS (with 12VDC transformer) external batteries. DC power wires are terminated at location **B** on the I/O Board - Figure 3.18 (Common lettering references are used for both 5400 and 5500 models).

Notes:

- The 5X00 does not charge batteries. Quality assurance maintenance procedures should be established if batteries are to be fully powered when used as back-up power source.
- Power supply voltage above 16.5 VDC may permanently damage the 5X00.
- When back up voltage falls below 9.0 volts, the 5X00 ceases to operate properly.
- Some switching DC power supplies not supplied by YSI may result in noisy readings.

Directions to Wire DC Power/DC Backup Power



WARNING: Disconnect external power to the unit before wiring. Follow all manufacturer's safety and installation instructions when providing power to the 5X00 via a DC power supply.



AVERTISSEMENT : déconnectez l'alimentation externe de l'unité avant d'effectuer le câblage. Suivez toutes les consignes de sécurité et d'installation du fabricant lorsque vous fournissez de l'alimentation au modèle 5X00 par un bloc d'alimentation à courant continu.

1. Perform steps 1-3 of 5X00 installation.
2. Open front panel - page 41.
3. Feed DC power cable through drilled hole in rubber grommet to location **B**. Terminal strip is removable.



CAUTION: Run high and low voltage cables through separate bulkhead and conduit.

4. Terminate DC power wires to pins (-) and (+) according to manufacturer instructions and any applicable local electrical codes.

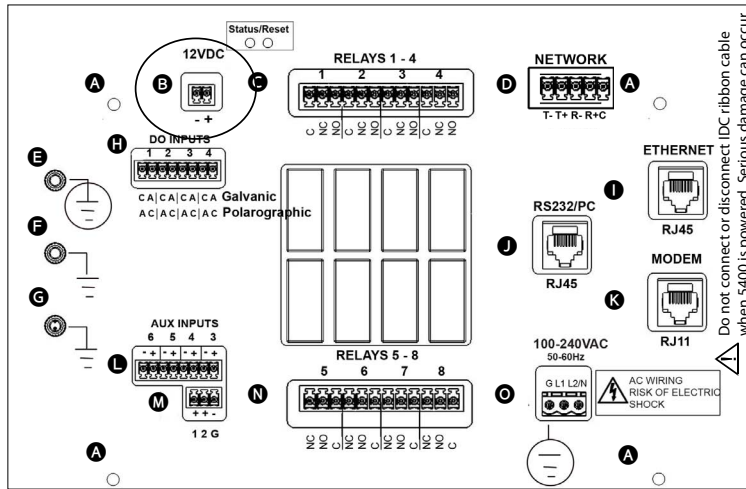

Figure 3.18

5. Complete other wiring to 5X00.
6. Close front panel - 41.
7. Test DC power.

Test DC Power

Connect DC power cable to power source. The enabled system values will display on Run Screen after initial YSI splash screen. Verify DC power at the **Menus** → **System** → **Version** menu - page 148.

See *Power Fail Menu* - page 138 for DC low battery trigger monitor and alarm information.

Note:

- The 5X00 will not power up if DC power supply wires are terminated incorrectly.

Step 5 Wire Sensor(s)



Depending on the 5X00 model, up to four DO sensors and four temperature sensors can be wired to the 5X00. All sensors are wired to the I/O Board - figure 3.19 and 3.19a. Use location E or F on metal plate to ground the DO sensor ground/drain wires. (Common lettering references are used for both 5400 and 5500 models). Follow the wiring instructions below to ensure proper sensor operation.

5400 YSI probe assembly 5421 has one galvanic DO sensor and one temperature sensor. YSI probe assembly 5420 has one galvanic DO sensor. The probe assemblies are shipped bare wire. YSI 5421 and has five wires. Two wires are for the DO sensor and are terminated at location H on the I/O board. Two wires are for the temperature sensor (YSI 5421) and are terminated at location L on the I/O board. Terminate the fifth wire (ground/drain wire) to location E or F of metal plate. The YSI 5420 probe assembly has three wires for the DO sensor and does not include any temperature sensor wires.

5500 ODO probe assemblies have five wires. Four ODO sensor wires are terminated at location H. Terminate the fifth (ground/drain wire) to location E or F of metal plate. Complete directions and wiring diagram are provided at step 4 (5500) - page 50. The ODO probe is a digital device and includes a temperature sensor.

Wire DO Sensors

Directions to Wire DO Sensor(s)

-  **WARNING:** Disconnect external power to the unit before wiring.
 1. Perform steps 1 - 4 of 5X00 installation.
 2. Open front panel - page 41.
 3. Feed DO cable through drilled hole in rubber grommet to location H. The terminal strip is removable.
-  **CAUTION:** Run high and low voltage cables through separate bulkhead and conduit.
- 5400**
 4. Terminate the DO sensor wires for the DO1, DO2, DO3, and/or DO4 system(s). Wire the DO sensor cathode wire to (+) terminals and the DO sensor anode wire to (-) terminals. Follow the coloring scheme described below when wiring the DO sensor.
 - YSI 5420 & 5421 galvanic DO sensor wires are white and black.
 - Terminate white wire to "C Galvanic".
 - Terminate black wire to "A Galvanic".
 - Terminate bare ground/drain wire to E or F on metal plate.

- Install a ring (eyelet) or spade (fork) terminal onto the ground bare wire before terminating ground wire to E or F.
- Multiple ODO ground/drain wires can be terminated to the same ground location on the metal plate.
- Return screw at E or F over terminal connection of ground wire.

YSI 5420 galvanic DO & 5421 galvanic DO/temperature analog sensor cable YSI	
Wire Function	Wire label/color
Cathode (C) (+)	WHITE
Anode (A) (-)	BLACK
YSI 5421 Temperature (There is no polarity for temperature sensor wire)	RED
YSI 5421 Temperature (There is no polarity for temperature sensor wire)	GREEN
Ground/drain wire	BARE

figures 3.19a and 3.19b. The upper and lower DO sensor terminal strips are inverted. Be sure ODO sensor wires follow the wire coding below.

YSI 6060250 ODO/temperature digital sensor cable YSI	
Wire Function	Color Coding
power/6.3 volts DC for ODO Probe	RED
GND/Sensor	GREEN
RS485 B/bidirectional data	WHITE
RS485 A/bidirectional data	BLACK
Ground/drain wire	BARE

- YSI 6060250 ODO DO sensor wires are red, green, white and black.
 - Terminate red wire to 1R ("1"=DO1 "R"=red) and/or 2R, 3R, 4R.
 - Terminate green wire to 1G ("1"=DO1 "G"=green) and/or 2G, 3G, 4G.
 - Terminate white wire to 1W ("1"=DO1 "W"=white) and/or 2W, 3W, 4W.
 - Terminate black wire to 1B ("1"=DO1 "B"=black) and/or 2B, 3B, 4B.
 - Terminate bare ground/drain wire to E or F on metal plate.

Notes ground/drain wire termination:

- Install a ring (eyelet) or spade (fork) terminal onto the ground bare wire before terminating ground wire to E or F.
- Multiple ODO ground/drain wires can be terminated to the same ground location on the metal plate.
- Return screw at E or F over terminal connection of ground wire.

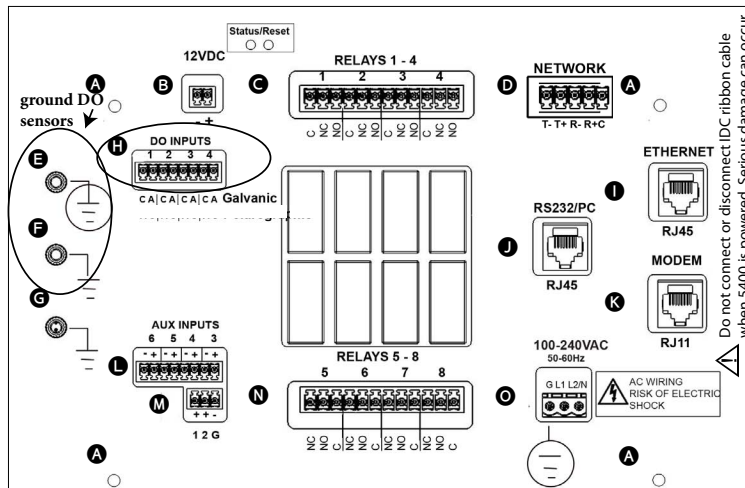

Figure 3.19

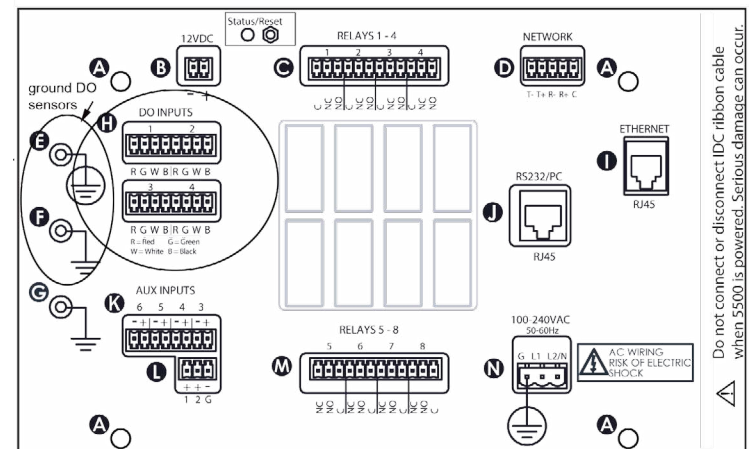

Figure 3.19a

Proceed to Step 5 following 5500 DO sensor wiring directions - page 52 to complete sensor wiring.

- 5500** 4. On 5500D instruments there are two terminal strips at location H. Wire system DO-1 and system DO-2 sensors to the upper terminal strip. Wire system DO-3 and system DO-4 sensors to the lower terminal strip - see

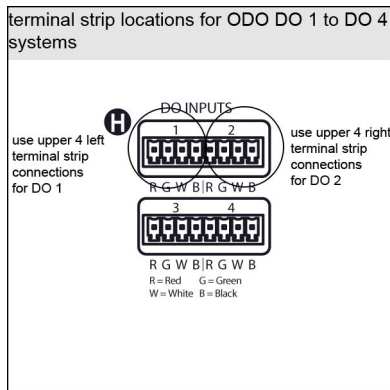

Figure 3.19b

5. Wire temperature sensors. Temperature sensors are wired as auxiliary inputs. See *Temperature Sensor(s)* - page 52.
6. Complete other wiring to configure 5X00 system.
7. Close Front panel -page 41.
8. Calibrate DO sensor - see Calibration “DO” on page 83.

⚠ CAUTION: Do not ground the probe body.

Test DO/Temperature Sensors

Apply power to 5X00. See *DO Sensor Setup* - page 173 to configure DO sensor inputs. See *Temperature Setup* - page 168. Calibrate the DO sensor, see DO calibration - page 81. Verify changes in sensor values occur when the sensor is placed in environments of different oxygen concentration and temperature. For example, the DO reading in saturated air for calibration versus the DO reading when the sensor is placed in a zero oxygen environment (mix 1 gram sodium sulfite in 0.5 liter of water).

Wire Temperature Sensor(s)

The 5X00 system will support four Temperature/Aux Analog inputs. Temperature sensors have 2 wires and are terminated at location **K** (5500) **L** (5400) on I/O Board - figure 3.20. Temperature sensor(s) must be thermistors with 10K at 25°C, see *Appendix 6 Alpha A Curve* - page 256.

Directions to Wire Temperature Sensor(s)

- ⚠ WARNING:** Disconnect external power to the unit before wiring.
- ⚠ AVERTISSEMENT :** déconnectez l'alimentation externe de l'unité avant d'effectuer un câblage quelconque.

1. Mount and install 5X00 and probes - pages 27 and 34.
2. Open front panel - page 41.
3. Feed temperature probe cable through drilled hole in rubber grommet to location **K** (5500) **L** (5400). The terminal strip is removable.

⚠ CAUTION: Run high and low voltage cables through separate bulkhead and conduit.

4. Terminate temperature sensor wires to Aux 3, Aux 4, Aux 5, and/or Aux 6 system. There is no polarity for temperature sensor wires; therefore, (+) and (-) terminals are interchangeable. Make sure the temperature sensor wires are terminated to the (+) and (-) terminals for the Aux system (3, 4, 5, 6) you are configuring.

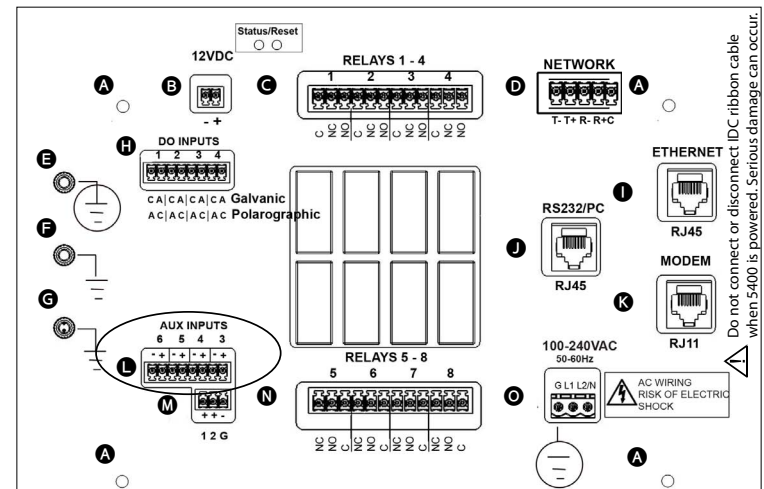

Figure 3.20

5. Complete other wiring to configure 5X00 system.
6. Close front panel - page 41
7. Test temperature sensor.

Note:

- Temperature sensors wired to Aux 3, Aux 4, Aux 5, and Aux 6 are displayed on the 5X00 by default as Temp 1, Temp 2, Temp 3, and Temp 4 respectively. For instructions on changing the default display settings, see section *Name Devices/Sensors* in Chapter 4 *Configuring the 5X00*.

Test Temperature Sensor

Apply power to 5X00. See Temperature Set up- page 168 to configure temperature system. Place the temperature sensor in solutions of varying temperature and verify the sensor readings with another temperature sensor.

Step 6 Wire Relay outputs

The 5X00 has eight (8) on board non-fused relays rated at 240VAC@5AMPs (110VAC@10AMPs) of switching capacity. Relays energize and de-energize peripheral control, alarm and/or timer devices. Terminate relay device wires to Normally Open (NO), Normally Closed (NC), and Common (C) sockets as required for the application. (See 5X00 I/O Board wiring diagram on inside of front panel for identification of relay number and pin position.) Relays 1-4 are terminated at location **C** on I/O Board. Relays 5-8 are terminated at location **N** on I/O Board - 3.21. (Common lettering references are used for both 5400 and 5500 models).

- CAUTION:** Do not overload relay(s). Check manufacturer specifications for inductive current/amp at power up. Use a contactor if necessary - figure 3.22. (Common lettering references are used for both 5400 and 5500 models).

Directions to Wire Relay Outputs

- WARNING:** Disconnect external power to the unit before wiring. If any of the relay contacts are connected to a “hazardous-live” circuit, ALL contacts on ALL relays must be considered “hazardous live” and appropriately protected from user contact outside the 5X00 enclosure.

- AVERTISSEMENT :** déconnectez l'alimentation externe de l'unité avant d'effectuer le câblage. Si un contact de relai quelconque est connecté à un circuit sous tension dangereuse, TOUS les contacts de TOUS les relais doivent être considérés comme étant sous tension dangereuse et doivent être protégés de façon adéquate de tout contact de l'utilisateur hors du boîtier du modèle 5X00.

1. Perform steps 1-4 of 5X00 installation and step 5 as required for application.

2. Open front panel - page 41.
3. Feed relay device wires through drilled hole in rubber grommet and to locations **C** and/or **N**. The terminal strip is removable.

- CAUTION:** Run high and low voltage cables through separate bulkhead and conduit.

4. Terminate relay device wires to the relay number (1-8) that will be configured for device. Wire devices to NC or NO and C pins depending on device configuration.

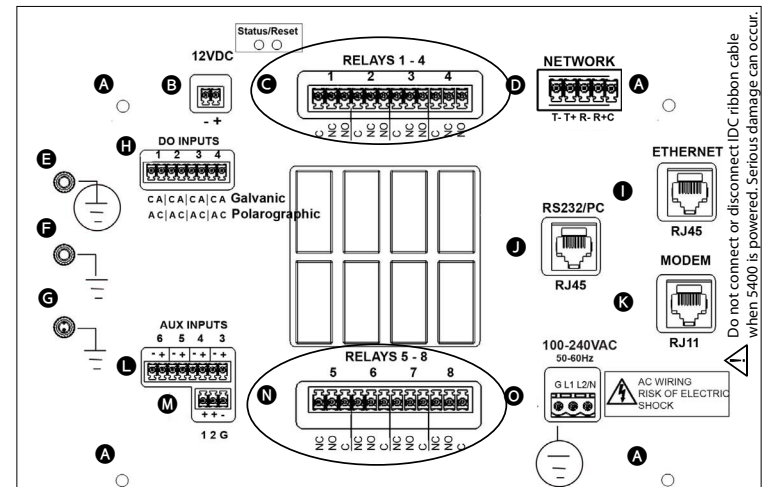

Figure 3.21

5. Complete other wiring to 5X00.
6. Close front panel -41.
7. Test relays.

Wiring a Contactor

The eight onboard relays are rated at 240VAC@5AMPs (110VAC@10AMPs) switching capacity. Contactors should be used for devices drawing current loads higher than relay specification. See figure 3.22 for contactor wiring.

Note:

- Contactor must meet the electrical requirements of the load.

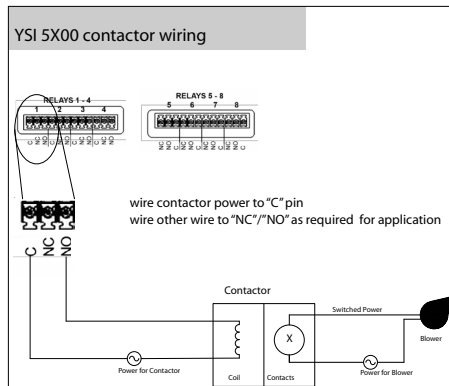

Figure 3.22

Test Relay Outputs:

Apply power to 5X00. Verify device activates at relay test. See *Relay Test* - page 144.

Note:

Entering the relay test menu turns off any active relays and disables any sensor, aux, and timer system relays from energizing regardless of value or condition. Systems are not reset when the Relay Test menu is exited. To reset systems after exiting the Relay Test menu, **power cycle the 5X00**.

Step 7 Wire Aux Inputs (Non Temperature)

The 5X00 has six (6) auxiliary inputs. All 6 auxiliary inputs can be used for digital (open/closed dry contacts) or analog (0-1VDC; 0-5VDC, or 4-20ma) inputs. Auxiliary inputs 3, 4, 5, and 6 can be configured for a temperature sensor. See *Temperature Probes* - page 52 for wiring directions. Aux inputs can be used for a variety of applications including: level switch, pressure switch, and/or an external instrument with an analog recorder output. Aux input wires are terminated at location **L** and/or **M** on I/O Board - figure 3.23. (See 5X00 I/O Board wiring diagram on inside of front panel for identification of aux system number and pin position.) See Digital Input example - figure 3.24, and Analog Input example - figure 3.25. (Common lettering references are used for both 5400 and 5500 models).

Notes:

- All aux inputs have input protection, the maximum input voltage should not exceed 6 VDC.
- Analog systems will not monitor and/or alarm properly if the device that is installed and configured operates outside the configured analog range.
- For proper digital input operation, use low impedance switches and wiring. The total resistance should not exceed 200 Ω (ohms).

Directions to Wire Aux Inputs (Non Temperature Inputs)



WARNING: Disconnect external power to the unit before wiring.



AVERTISSEMENT : déconnectez l'alimentation externe de l'unité avant d'effectuer un câblage quelconque.

1. Perform steps 1-4 of 5X00 installation and steps 5 -6 as required for the application.
2. Open front panel - page 41 .
3. Feed auxiliary device cable(s) through drilled hole in rubber grommet to locations **L** and/or **M**. The terminal strip is removable.



CAUTION: Run high and low voltage cables through separate bulkhead and conduit.

4. For Aux 3, 4, 5, & 6 use the terminal strip located at **L**, using (+) terminal strip port for non ground wire and (-) for ground wire. For Aux 1 and 2, use terminal strip located at **M**. "G" pin is the common ground for Aux 1 and 2.

See Digital Input example - figure 3.24 and Analog Input example - figure 3.25.

CAUTION: The auxiliary inputs are not isolated. Devices connected must be electrically isolated from ground and the water.

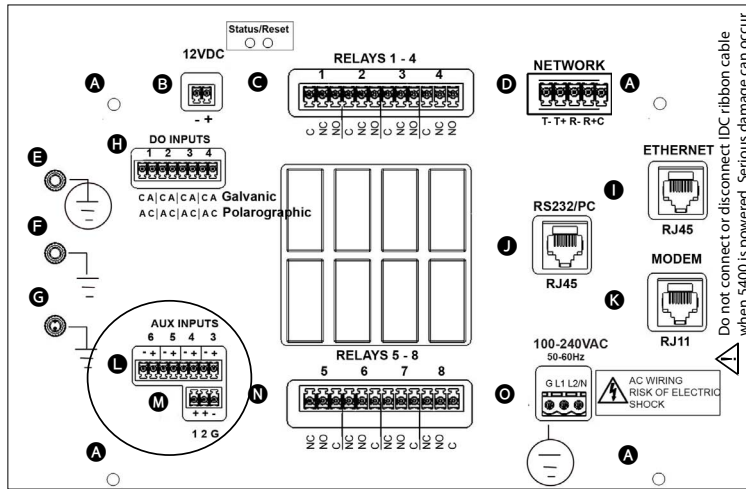

Figure 3.23

5. Complete other wiring to 5X00.
6. Close front panel - page 41.
7. Test aux systems.

Test Auxiliary Input Devices

Apply power to 5X00. See *Aux Setup* - digital page 165 and analog (non temperature) page 166 for configuration information. Verify display, control, and/or alarm functionality based on user defined configuration.

Wire Aux Digital Input

1. Install aux digital device according to manufacturer's instructions.
2. Connect switch wires to Aux Input 1 - 6. Connect ground wire to (G) at location M for aux 1 and 2 or to (-) at L for aux 3, 4, 5, or 6. Connect the other wire to (+) L and to 1 or 2 at M.

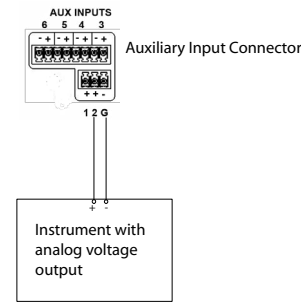

⚠ CAUTION: Do not input external voltage.

Figure 3.24

Wire Aux Analog Input

1. Install analog instrument according to manufacturer's instructions.
2. Connect analog instrument wires to Aux Input 1 - 6. Connect ground wire to the (G) at M for aux 1 and 2 or to (-) at L for aux 3, 4, 5, or 6. Connect the other wire to 1 or 2 at M for aux 1 and 2 or to (+) at L for aux 3, 4, 5, or 6.

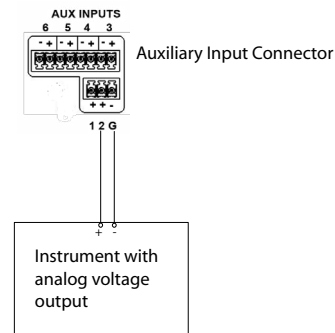

⚠ CAUTION: Observe correct polarity on analog input.

Figure 3.25

Step 8 Wire Network

Multiple 5X00 and 5200A instruments can be networked using the RS485 network ports. A node network consists of one master and up to 31 slaves. On a network, the master is the point of access for the AquaManager PC software program. In addition, the master sends all serial to ethernet device emails. Communication hardware (RS232 or serial to ethernet device) is installed on the master instrument (node) only.

RS485 network wiring can span distances up to 4000 feet (1220m). This maximum distance (4000 ft) is for the total network distance, not the distance between networked units (*see Notes below). RS485 ports are optically isolated for safety, to reduce noise, and to help eliminate ground loops. No further isolation is required.

Network traffic refers to the constant communication between the master and all slaves on the network. Example - slave node 3 is configured to generate an alarm if the temperature drops below 70°F. The master node is configured to send email alarms via TCP/IP using the serial to ethernet device. The master node sends an email alarm when slave node 3 reports a temperature value below 70° F to the master.

 AquaManager is a valuable tool for monitoring and controlling node networks.

Notes:

- *Use an RS485 Line Extender/Booster for distances over 4000' (1220m). Communication failures may occur without it. Mount the booster in an area where it is protected from moisture.
- Multiple networks connected to a PC via RS232 require separate PC COM ports for simultaneous AquaManager mapping and autopolling.
- Legacy 5200s can not be on the same network as 5200As and/or 5X00s. However, Legacy 5200s can communicate with AquaManager and Legacy 5200 data will be stored in the same database as 5200A and 5X00 data.
- Network traffic speed operates at ~ 230 KB and is not user selectable.
- Remove network terminal strip from any networked slave that is not powered. Network rewiring is required if a stub (*see note below) is created when a slave is taken off the network. See valid network configuration - see figure 3.30.

Note:

- * A stub is created when the last wired network terminal strip is not connected to a network slave - figure 3.26. (Common lettering references are used for both 5400 and 5500 models).

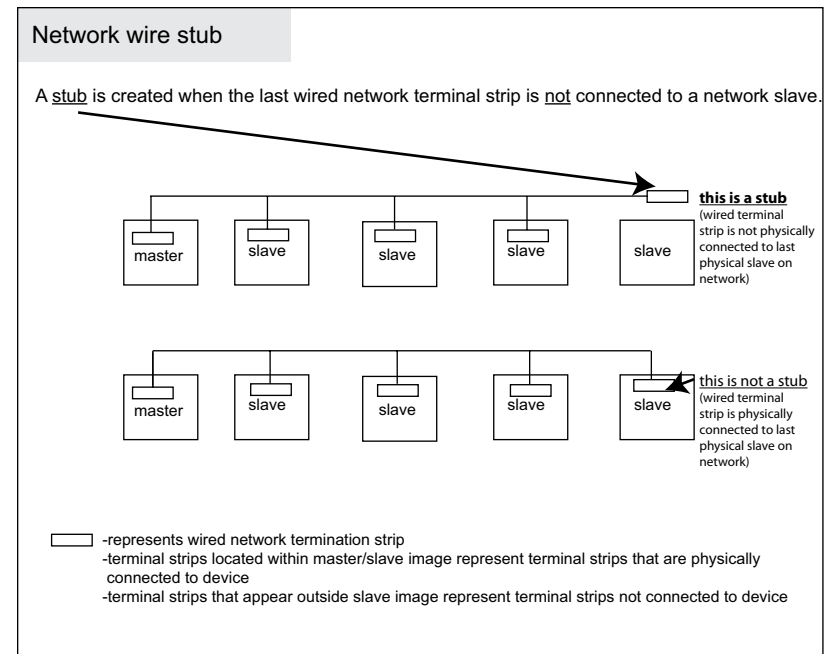

Figure 3.26

Directions to Wire Network

Network wiring consists of **two pair of twisted pair cable plus a communications com wire**. Category 5 ethernet cable is recommended. Network wires are terminated at location **D** on I/O Board - figure 3.27. (Common lettering references are used for both 5400 and 5500 models)



WARNING: Disconnect external power to the unit before wiring.



AVERTISSEMENT : déconnectez l'alimentation externe de l'unité avant d'effectuer un câblage quelconque.

1. Perform steps 1-4 of 5X00 installation and steps 5 -7 as required for the application.
2. Open front panel - page 41.
3. Strip five wires to terminate at network termination strip. Use appropriate wire stripper to avoid wire nicks.
4. Feed networking cable through drilled hole in rubber grommet and to location **D**. The terminal strip is removable.

Note:

- It is essential that wires be terminated cleanly. Nicks (stray wires, not cleanly terminated) can result in unreliable network communication.

CAUTION: Run high and low voltage wires/cables through separate bulkhead and conduit.

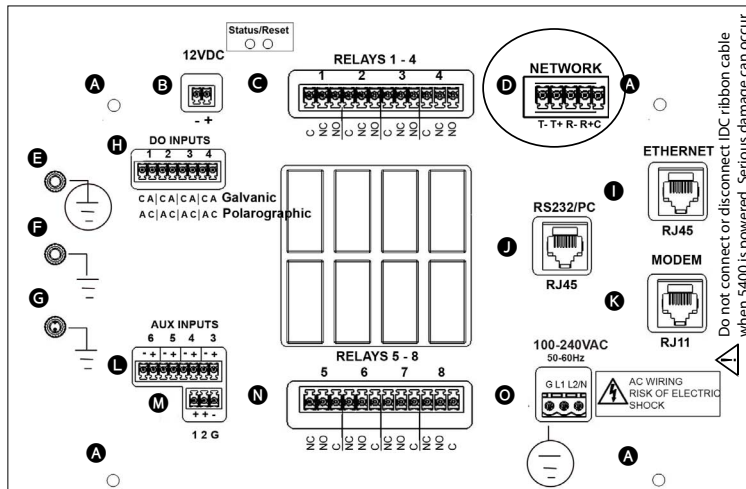

Figure 3.27

5. Terminate wires as described using category 5 cable: (color scheme may be different than described below.)
 - Pair #1 wires: solid blue and white with blue stripe
 - Pair #2 wires: solid orange and white with orange stripe
 - 1 wire green
 - Secure unused wires to avoid potential for shorting

Wire the master as follows:

<u>Wire Color</u>	<u>Terminal</u>
solid orange	T(-)
white with orange stripe	T(+)
solid blue	R(-)
white with blue stripe	R(+)
green	Communications Common (C)

Wire all slaves as follows:

<u>Wire Color</u>	<u>Terminal</u>
solid blue	T(-)
white with blue stripe	T(+)
solid orange	R(-)
white with orange stripe	R(+)
green	Communications Common (C)

Figure 3.28 is a wiring diagram for the most common 5X00 network configuration where a master 5X00 is the first physical device in the network.

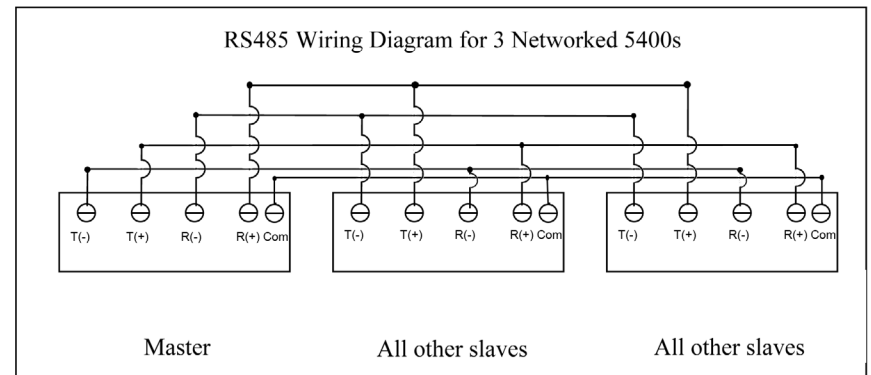

Figure 3.28

6. Wire all network terminal strips prior to network testing but only connect a network terminal strip to the first and last devices on the network (*see note below). Configure network menu and follow testing procedure as described starting on 97. Slave devices are tested one by one as they are added to the network. Network testing cannot be done if stubs exist (** see note below).

Notes:

- *For testing - If the master is not the first physical device on the network, place network terminal strip on the master and on the first and last physical devices on the network. (In this case two slaves will need to be tested at the same time.) - figure 3.29.
- **A stub is created when the last wired network terminal strip is not connected to a network slave - figure 3.26.

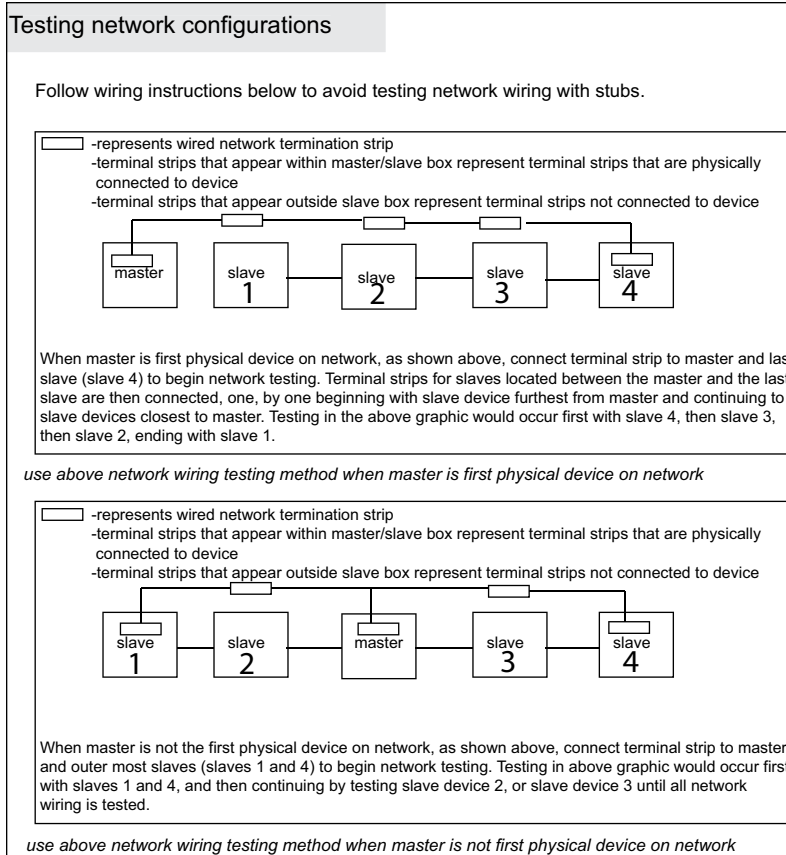

Figure 3.29

7. Close front panel - page 41.

5X00 networks must be configured point to point (instrument to instrument). Network wiring cannot contain loops, stars, or stubs - figure 3.30.

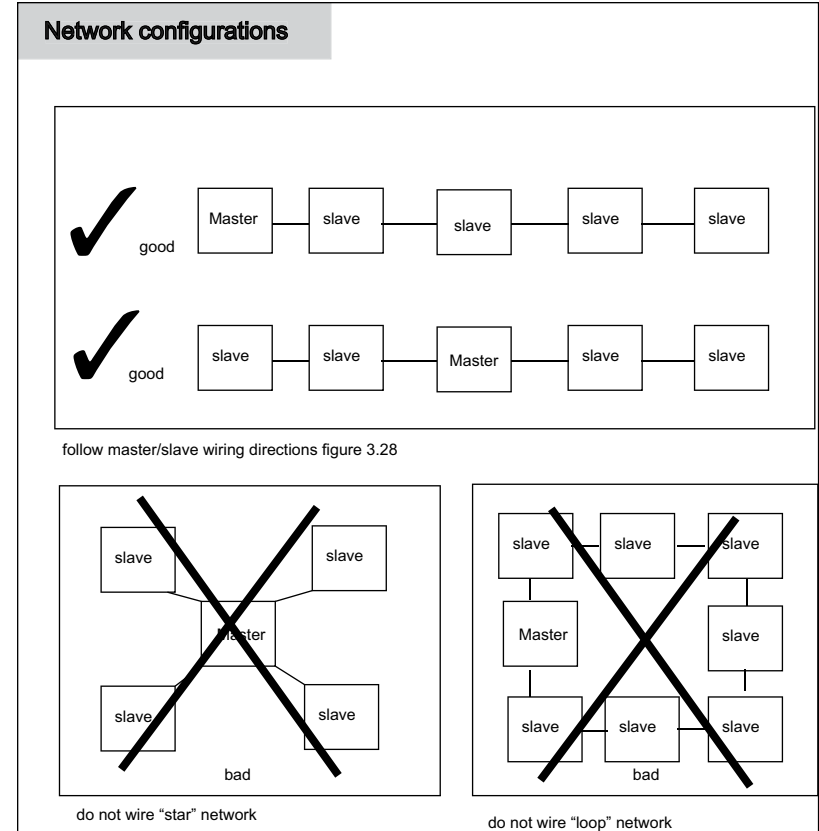

Figure 3.30

Test Network Wiring and Configuration

Apply power to only the master and last slave device on the network. If the master is not the first physical device on the network, apply power to the master and the first and last physical slave devices on the network. See *Network* beginning on page 96.

Step 9 Wire and Install Communication Equipment

Communication equipment must be installed in order to communicate, either locally or remotely, with the 5X00. The communication connection can be made locally (RS232) or remotely with a serial to ethernet device. **Only 1 connection method can be used at a time.** AquaManager supports both connection methods.

Notes:

- Firmware can only be uploaded to an instrument using a local RS232 connection. See *Downloader* - page 126.
- On a network, install and configure RS232 or the serial to ethernet device hardware on the master node only.

Email Alarming

Email alarming can be configured in 1 of 2 ways:



- from PC running AutoPoll Program that is included with AquaManager software (PC must have internet connection). This is referred to as *Aqua-Manager email*.
- via a serial to ethernet* device with TCP/IP connection at the master 5X00. This is referred to as *5X00 email*.

*Serial to ethernet connection requires access to an SMTP server accessible by the local network.

RS232 Communication

Use Category 5e patch cable from RS232 port at location **J** - figure 3.31 of I/O Board to PC using RJ45 to DB9 adapter. (Common lettering references are used for both 5400 and 5500 models).

Directions to Wire Direct RS232 PC Connection

-  **WARNING:** Disconnect external power to the unit before wiring.
-  **AVERTISSEMENT :** déconnectez l'alimentation externe de l'unité avant d'effectuer un câblage quelconque.

1. Perform steps 1-4 of 5X00 installation and steps 5 - 8 as required for the application.
2. Open front panel - page 41.

3. Feed direct connect cable through drilled hole of rubber grommet and to location **J**.

 **CAUTION:** Run high and low voltage cables through separate bulkhead and conduit.

4. Connect one end of communication cable to RJ45 at location **J**. Connect other end to RS232 PC com port using RJ45 to DB9 adapter figure 3.31.

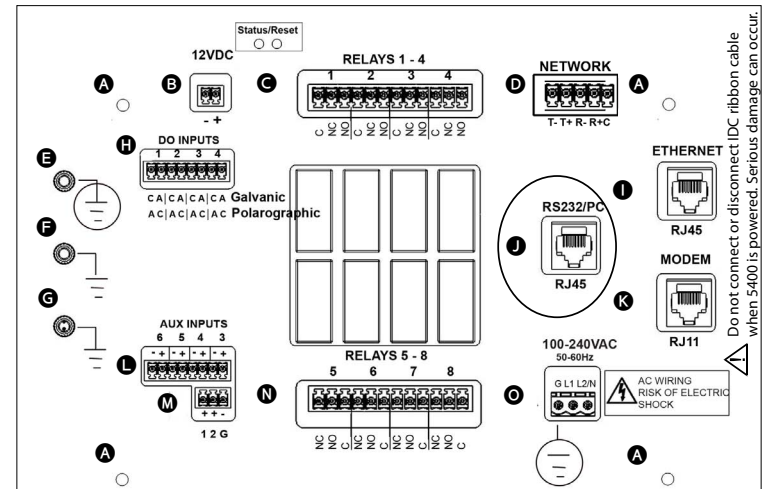



figure 3.31

5. Complete other wiring to configure 5X00 system.
6. Close front panel - page 41.
7. Test RS232 communication.

Notes:

-  - When using a USB-Serial Adapter, verify that the port number assigned during driver installation is the same port configured when using AquaManager and/or the Firmware Updater
- Use only a Tripp-Lite Keyspan USB-Serial Adapter, model USA-19HS YSI p/n 773 (64-bit).
- When making RS232 cable runs greater than 100 feet (30.5 m), use an RS232 Line Extender/Booster. Mount the booster in an area where it is protected from moisture.

Test RS232 Communications

Apply power to 5X00. Insert node into AquaManager program. See AquaManager Help to insert node and configure communication in PC application. Poll node. If wired and configured properly, AquaManager will obtain 5X00 configuration and 5X00 logs.

Ethernet (TCP/IP) Module Communication

The optional serial to ethernet device must be installed on the 5X00 control board when using TCP/IP for communication. Installation instructions are provided with the optional serial to ethernet device.

Notes:

- See *Menus* → *System* → *Communications* → *Ethernet* - page 92 for configuration information.
- An SMTP server accessible by the local network must be provided for ethernet connection.

Consult the network administrator to verify compatibility for ethernet configuration.

Step 10 Install and Wire OEM/REM instruments

1. Perform steps 1-4 of 5X00 installation and steps 5 - 8 as required for the application.

Note:

- At step 8, Wire Network - page 60, OEM and REM instruments are always slave devices on a network.
2. Follow all installation and wiring steps as required for application as provided at Chapter 3 of separate manual "OEM and REM Safety and Installation Guide."

Lightning and Surge Protection

AC line voltage surge suppressors protect field equipment on any AC line to ground from damage due to electrical transients induced in the interconnecting power lines from lightning discharges and other high voltage surges. Surge protection devices are strongly recommended to protect your equipment from secondary surges and lightning on outdoor installations. Follow the recommendations provided when choosing and incorporating surge protection devices into your operation:

Recommendations:

- Surge suppression devices should be located on the AC line supplying power to the 5X00 and any signal lines connecting the 5X00.
- The unit should include noise filtering, common mode, and normal mode suppression and nanosecond reaction time.
- Surge suppressors should be internally fused to remove the load if the unit is overloaded or the internal protection fails.
- Signal line suppressors protect low voltage signals and relay outputs from damage due to electrical transients induced in the signal lines from lightning discharges or nearby electrical devices.
- Signal line suppressors should be installed at each end of an analog loop.
- Relay outputs should be protected at the receiver end.
- Signal line suppressors should consist of a three-element gas tube followed by metal oxide varistors and suppressor diodes.
- The protective elements should be matched such that high-energy surge voltages trigger the gas surge arrester, while low energy or surge voltages affect the MOV's and suppressor diodes.
- Lightning protection devices should be located as close to the 5X00 as possible and wired in accordance with the National Electric Code in approved watertight enclosures.



CAUTION: This or any other installation procedure cannot protect against a direct lightning strike. YSI Incorporated cannot accept liability for damage due to lightning or secondary surges.

Sealants, Desiccants, and Securing 5X00

Environmental conditions can promote the formation of condensation in and around the 5X00. It is very important to follow the steps below to prevent damage to the electronic components and extend the life of the 5X00 system.

1. Place solid rubber grommets in bulkhead fittings that have no electrical connections.
2. If using optional conduit fittings (YSI p/n 065926UL) in place of bulkhead fittings, industrial encapsulant (YSI p/n 065921 conduit sealer) must be used to prevent moisture from entering the 5X00 enclosure. Apply the sealant after all wiring and connections are complete. Failure to use industrial encapsulant may result in damage to the 5X00.
3. Desiccant pack must be replaced whenever the 5X00 enclosure is opened (Desiccant pack, YSI p/n 006506). Desiccant absorbs moisture captured within the enclosure.

4. Ensure that the rubber gasket is seated between front panel and enclosure whenever enclosure is closed.
5. Replace front panel making sure that ribbon cable is not trapped in the gasket channel before inserting mounting screws.
6. Tighten mounting screws, making sure not to cross thread. The screws are stainless steel and the receiving threads are brass. Do not over-tighten!



WARNING: The 5X00 utilizes sensitive solid-state devices that can be damaged by static shock. Installers must observe accepted ESD (Electro-Static Discharge) procedures while connecting cabling to the 5X00 I/O plate or any other internal component or damage may result.



AVERTISSEMENT : le modèle 5X00 utilise des appareils transistorisés sensibles pouvant être endommagés par des décharges d'électricité statique. Les installateurs doivent observer les procédures de protection acceptées contre les décharges électrostatiques lors du câblage à la carte d'E/S du modèle 5X00 ou à tout autre composant interne afin d'éviter tout risque de dommage.

4

Configuring 5X00 Systems

- Front panel keys
- Run Screen
- Navigating menus
- Menu structure
- Configuring 5X00 systems

5X00 Configuration and Monitoring

This chapter provides information on the 5X00's front panel, navigating menus, and menu functionality.

The front panel - figure 4.1, is the front component of the 5X00 enclosure. The front panel contains the 5X00 display and seven keys. Use the keys to navigate menus and instrument system information.

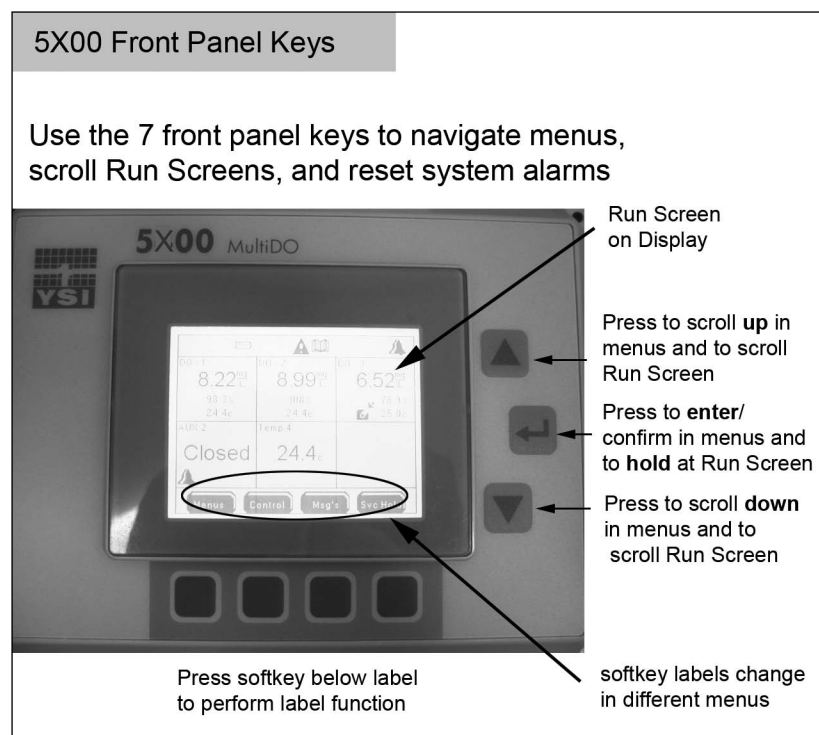







Figure 4.1





 This icon indicates helpful information for AquaManager users and is used throughout this chapter. AquaManager provides access to 5X00 system information from a PC. Most 5X00 configuration and monitoring can be done using AquaManager. See *Chapter 5 AquaManager* -page 197.

NEW With new features in this release of AquaManager, it is strongly recommended that AquaManager be used to configure all 5X00, IOEM, REM systems and sensor setup menus. AquaManager is required to upload IOEM mode configuration to the instrument. In addition, AquaManager must be used to upload all sensor setup>sensor system>output 4/20mA menus which menus include configuration of IOEM slave and channel to be used for a sensor system output. AquaManager includes software checks that help to validate IOEM 4/20mA output assignment configuration.

Front Panel Keys

There are seven (7) 5X00 front panel keys - figure 4.1. Use  and  keys to scroll and highlight menu lists and to scroll through multiple Run Screens. Use  key to select and enter highlighted submenu item and to hold one of multiple run screens from scrolling. Hold is not an option when there is only one run screen. Run screens can be scrolled when held by pressing  and  keys.

Notes:

- Press and hold  and  longer than one second for continuous scrolling.
- Use  and  to scroll and view additional menu items when a scroll bar appears to right of screen.
- Pressing any of the four bottom keys resets any active alarm system. See *General Alarm* - page 131.

Softkeys

Softkey labels appear on the bottom of the display and identify the function of the buttons below them. Softkey labels change in different menus. Softkey labels and corresponding softkey functions are listed in table 4.1.

Note:

- Not all menus and screens display four softkey labels. If there is no softkey label, that softkey has no functionality.



















Softkey label	Function
	Access to Main Menu including: calibration submenu system submenu sensor setup submenu timers submenus
	Display active non timer control & alarm system(s)
	Access to Msg's (Messages) Menu including: sensor logs event logs calibration logs
	Activate Service Hold
	Exit menu return to Run Screen saving menu configuration changes.
	Exit menu (to previous menu) without saving configuration changes.
	Back to previous menu. Changes to configurations are saved at return to Run Screen.
	Prompt to take next action. i.e. enter user value at calibration menus.
	Save alpha and numeric configurations and calibrations.
 	Disable/Enable menu option. i.e. buzzer.
 	Scroll left and right in alpha and numeric keypad screens.
	To acknowledge and save sensor calibration.
 	Prompt to confirm "Are you sure?" message when performing certain functions. i.e. reset to factory and clear data log menus.
 	Digital input control configuration from Sensor Setup Menu.



table 4.1

Run Screen

The Run Screen displays measurements and inputs from enabled sensors and conditions - figure 4.2. At power up, the Run Screen is displayed immediately after the YSI splash screen (the YSI splash screen appears for approximately 2 seconds). Icons displayed at the Run Screen represent individual and systemwide conditions. See *Run Screen Icons* - page 76.

Run Screen and sensor display formats are user selectable. See *Display Settings* - 123 and *Sensor Setup Menu* - page 150.

Notes:

- **The Run Screen must be displayed during normal operation.**
- **All alarm functions (5X00 email alarms, energizing of enabled alarm relays, alarm icons, and buzzer) are suspended when in 5X00 instrument menus.** Alarm systems are reset when menus are exited to Run Screen.
-  - Always manually poll the 5X00 after uploading configuration changes and verify the uploaded information is retained. When configuration changes are uploaded using AquaManager at the same time configuration changes are being made at the instrument, the AquaManager uploads may not be saved depending on the timing of keystrokes at the 5X00.
-  - **The Run Screen must be displayed during normal operation.** If the 5X00 is not at the run screen during AquaManager uploading, pressing  at the 5X00 will only save certain configuration changes.
- At power up, 5X00 systems have a 30 second hold off allowing sensor values to stabilize before enabling any control and/or alarm devices.

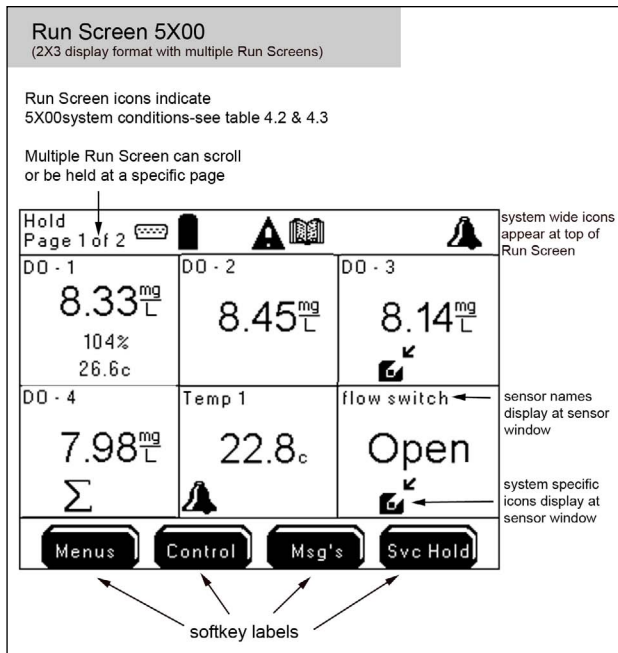

Figure 4.2

Run Screen Icons

Icons identify control, alarm, timer, power, service, and communication information. Icons along the top of the Run Screen indicate 5X00 systemwide conditions - table 4.2. Icons displayed within a sensor window indicate condition(s) specific to that system - table 4.3.

Notes:

- Control icons display when the control relay(s) is active.
- General alarm icon, buzzer, 5X00 emails, and enabled alarm relay(s) [sensor and general alarm] remain active until one of the bottom four 5X00 front panel keys is pressed, regardless if the alarm condition no longer exists.
- Relays, and corresponding icons, that de-energize for Svr Hold, calibration, and/or factory resets are restored after 30 seconds of completing Svr hold, calibration, and/or factory resets. For exceptions, see menu specific information in this chapter.
- With alarms enabled, alarm icons appear at the systemwide location and individual system location regardless if a relay is assigned to the sensor alarm or general alarm system.

ICONS (systemwide)	Meaning	Notes
	RS232 communication	blinking icon indicates "force serial port" is enabled
	TCP/IP communication	ethernet module is installed and being used for TCP/IP communication
	operating in acceptable DC power range	
	DC power is ≤ low battery trigger	
	5X00 is password protected	
	sensor (data) logs have information	to view logs
	one or more control systems is active	to view active systems
	feed timer is active	
	one or more 10 event timer is active	
	probe timer needs to be reset	
	General Alarm is active	

table 4.2







ICONS (Sensor & Aux)	Meaning	Notes
	sensor system is in alarm	
	set point control mode low range control relay is energized (to raise sensor value)	
	set point control mode high range control relay is energized (to lower sensor value)	
	set point control mode DO low range 2 control relay is energized (to raise sensor value)	
	set point control mode DO high range 2 control relay is energized (to lower sensor value)	
	PID/PWM or PID 4/20mA control mode is configured for system	

table 4.3

Menus

5X00 firmware is structured using menus that enable you to easily configure and view system status, messages, and logs. The menu structure and screen formats are very intuitive. Menus are structured in hierarchical fashion. See *Appendix 3 "Menu Maps"* - beginning on page 225 . Example - figure 4.3 illustrates the menu path to configure data logging interval.

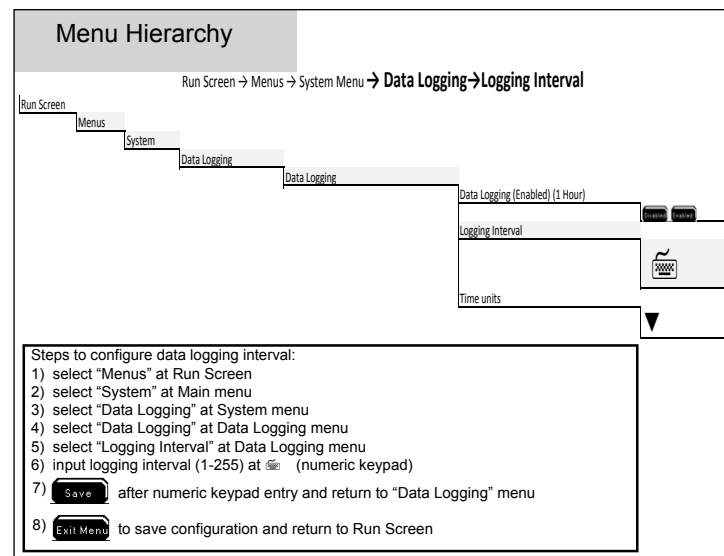

Figure 4.3

Submenu Screen Types

The 5X00 includes numeric, alpha/numeric, and pull-down submenus - Figure 4.4. See *Front panel keys - page 73*, to navigate, enter, configure, and view submenus.

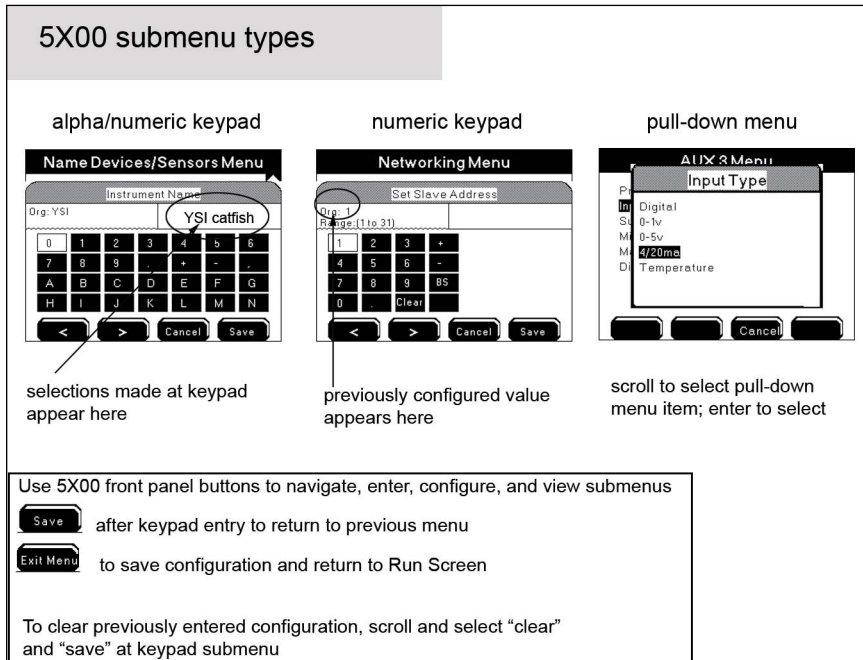

Figure 4.4

This symbol indicates that alpha/numeric or numeric keypad entry is required. This symbol is used in the menu map appendix starting on 225 and in directions for menu configuration (this chapter). Use front panel keys to scroll and to select entries.

The remainder of this chapter provides information on 5X00 menus and submenus and their function. Menu structure and information is provided in hierarchical order starting with the menu. Information on , , and menu is provided after the menu sections.

Main Menu

Press at the Run Screen to enter the Main Menu.

All system configuration is done through this menu. The four Main Menu submenus are Calibration, System, Sensor Setup, and Timers.

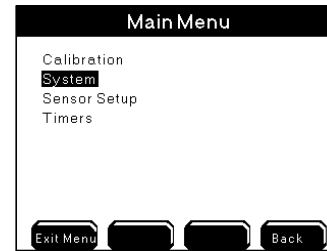

Calibration Menu

DO sensor(s) must be user calibrated to ensure accurate measurements. Calibrate DO sensors at the Calibration Menu. Entering the Calibration Menu de-energizes control and alarm relays for the DO system being calibrated. Energized DO control relays for systems not being calibrated remain energized including any/all temperature systems regardless if they are the configured temperature (temp) source for the DO sensor being calibrated (5400 only). If necessary, disable any temperature relays for the associated DO sensor in the Sensor Setup menu. There is a 30 second hold off period for control and alarm relays after pressing or at the calibration menu. The hold off period allows sensors time to stabilize before processing readings for controlling and alarming purposes.

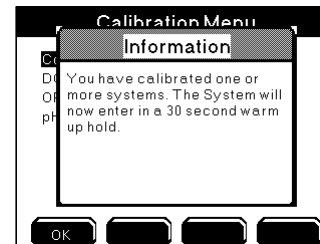

Notes:

- Active Aux and Timer relays do not de-energize at calibration menu.

- A “Check probe” error message during calibration means that the sensor is unable to calibrate within the 5X00’s specifications. This may indicate improper sensor wiring (page 49), 5X00 location (page 27), sensor location or (page 34), the need to service the sensor, or a failed sensor.
- Calibration of temperature sensors is not required and is not available.
- Energized alarm relays for all systems de-energize when a front panel key is pressed to enter the calibration menu. Alarm systems are not reset until **Exit Menu** is pressed to return the instrument to the run screen.

Getting Ready to Calibrate

Calibrate DO sensor(s) by performing a one point calibration. Calibration can be done to 100% Saturation (Sat) or mg/L. Calibrating to %Sat automatically calibrates to mg/L and vice versa so it is only necessary to calibrate one or the other, not both. For both ease and accuracy, YSI recommends calibrating in %Sat. Salinity compensation for the mg/L readings is obtained from the user entered ppt value. This value can be entered and modified in the DO sensor setup menu.

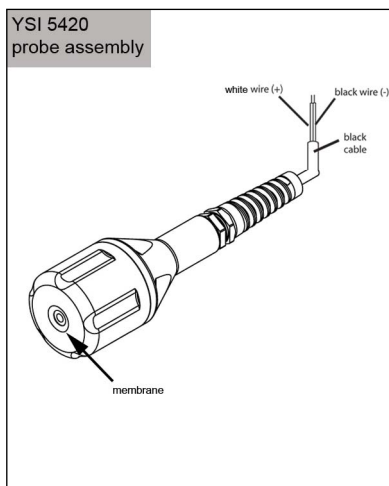

Figure 4.6



Figure 4.7

Notes:

- A sensor must be enabled in order to calibrate.
- For YSI 626250 cable/probe assemblies, keep the sensor guard installed during the calibration to protect the membrane from possible physical damage - figure 4.7.
- When calibrating to mg/L, use a ring stand and clamp to secure the sensor in the calibration water sample.
- Older sensors may take longer to calibrate than new ones because the sensor readings may take longer to stabilize.

Calibration Log

Calibration data is stored in the 5X00 calibration log. A calibration data record includes sensor information, the time and date of the calibration, and the calibration method. Press **Msg's** at the Run Screen to view the calibration log .

Notes:

- Use AquaManager to view and save calibration data on a PC. In addition to the calibration log information listed above, AquaManager calibration logs also include user inputs 1 and 2.
- Information from cancelled calibrations is not stored.

DO

Menus → Calibration → DO

Directions to Calibrate DO Sensor %Sat

1. If you have not already done so, locate and install the sensor if using a YSI 5422, see probe installation instructions included with the sensor.
2. Next, install a new membrane, or sensor cap, if necessary. See instructions included with membrane kit.
3. Verify that the sensor type and membrane type are configured correctly in the DO Sensor Setup menu at the 5X00.
4. Read *Getting Ready to Calibrate* - page 82.
5. Verify that the configured salinity (ppt) value in the DO Sensor Setup menu is correct. The entered salinity value should equal the salinity of the water being monitored (not the calibration solution). If necessary, enter the correct the salinity value (ppt).

Menus → Sensor Setup → DO → ppt

- Verify that the local elevation in the DO Sensor Setup menu is correct. If necessary, enter the correct elevation.

Menus → Sensor Setup → DO → Elevation

- Create a 100% water-saturated air environment for the DO sensor:

For a YSI 5520 and 5521 galvanic sensor, there are two options for the %Sat calibration environment:

5400

- Calibrate the galvanic sensor in air by exposing it to air and removing any water droplets from the membrane with a lint free cloth - figure 4.6, 82.

5400

- If the temperature source for the DO sensor being calibrated is not coming from a temperature sensor located on the DO sensor's probe assembly, make sure that the temperature value being reported by the source is equivalent to the temperature at the DO sensor's calibration location.

Menus → Sensor Setup → DO → Temp Source (User Defined)

- Enter DO calibration menu

Menus → Calibration → DO → Sat

- Allow approximately 10 minutes for the sensor to settle in the calibration environment and for the temperature to equilibrate.

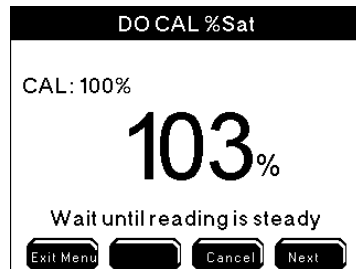

- After 10 minutes, verify that the DO reading shows no significant change for approximately 30 seconds. Then press **Next** to complete calibration OR press **Cancel** to abort the calibration without saving.
- Press **OK** to save calibration and return to Run Screen.
- Remove the probe from its calibration chamber.
- Rinse sensor in tap or purified water and place the probe assembly back in its monitoring location.

Directions to Calibrate DO Sensor mg/L

A large bucket can be used when calibrating the DO mg/L reading. Be sure to provide sample flow across the membrane or sensor cap by physically stirring the probe or using a stirrer such as a stir bar.

- The DO sensor requires a sample flow rate of at least 3 inches (~7.62 cm) per second if using the 2.0 mil PE membrane (blue) and at least 6 inches (~15.24 cm) per second if using the 2.0 mil Teflon membrane (gray).

- If you have not already done so, locate and install the sensor if using a YSI 5422, see probe installation instructions included with the sensor.
- Next, install a new membrane, or sensor cap, if necessary. See instructions included with membrane kit.

5400

- Verify that the sensor type and membrane type are configured correctly in the DO Sensor Setup menu at the 5X00.

- Read *Getting Ready to Calibrate* - page 82.

- Verify that the configured salinity (ppt) value in the DO Sensor Setup menu is correct. The entered salinity value should equal the salinity of the water being monitored (not the calibration solution). If necessary, enter the correct the salinity value (ppt).

Menus → Sensor Setup → DO → ppt

- Place the DO probe in a water sample with a known DO concentration (the DO mg/L value can be determined from another recently calibrated DO instrument or from a Winkler titration).

- If the temperature source for the DO sensor being calibrated is not coming from a temperature sensor located on the DO sensor's probe assembly, make sure that the temperature value being reported by the source is equivalent to the temperature at the DO sensor's calibration location.

Menus → Sensor Setup → DO → Temp Source (User Defined)



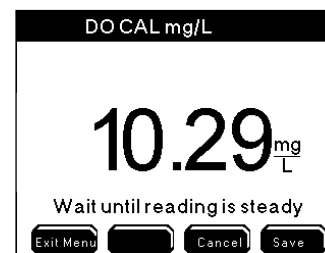

- Enter DO calibration menu

Menus → Calibration → DO → mg/l

- Allow the probe to stabilize for approximately one minute.



- After one minute, verify that the DO value shows no significant change for approximately 30 seconds. Then, press **Next** to complete the calibration OR press **Cancel** to escape calibration and return to calibration menu without saving.

11.  Using the arrow keys to select numbers on the numeric keypad, enter the known DO value in mg/L. Press  to confirm each number selection.
12. Press  to confirm the entered value OR press  to abort the calibration without saving any changes.
13. Press  to save the calibration and return to the Run Screen.
14. Rinse sensor in tap or purified water and place the probe assembly back in its monitoring location.
15. Rinse sensor in tap or purified water and place probe assembly in system stream.



Note:
 - Elevation is not required for mg/L Calibration.

Local vs Remote Instruments

NEW A local instrument on a 5X00 network is defined as a 5X00 instrument that is using its own relay output as a sensor system control or alarm. So, for example if a 5X00 (s/n 55-1111111) General Alarm system is configured to use its own (5X00 s/n 53-1111111) relay 1 to energize when a general alarm is detected, the relay assignment is considered a **local** relay configuration. If this same 5X00's (s/n 55-1111111) General Alarm system is configured to use a networked 5500 (s/n 55-2222222) relay 1, the relay configuration is considered a **remote** relay configuration. IOEM input and IOEM and REM output channels are always considered to be remote configurations because IOEM and REM instruments input and output devices are always configured to a networked 5X00 instrument system. Knowing the difference between local and remote instruments is important since certain menus like 5X00 system and sensor setup menus display local versus remote instrument names differently.

System Menu



Menus → System

The 5400 System Menu contains 18 submenus. The 5500D-01, 5500D-02 and 5500D-04 System Menu contains 19 submenus. Use System submenus to configure non-sensor and non-timer systems. System submenus are shown below. Press  at the Run Screen to enter the Main Menu. Use ▲ ▼ to scroll and highlight a System submenu. Press  to select and enter a highlighted menu. Configuration changes are saved when  is pressed.

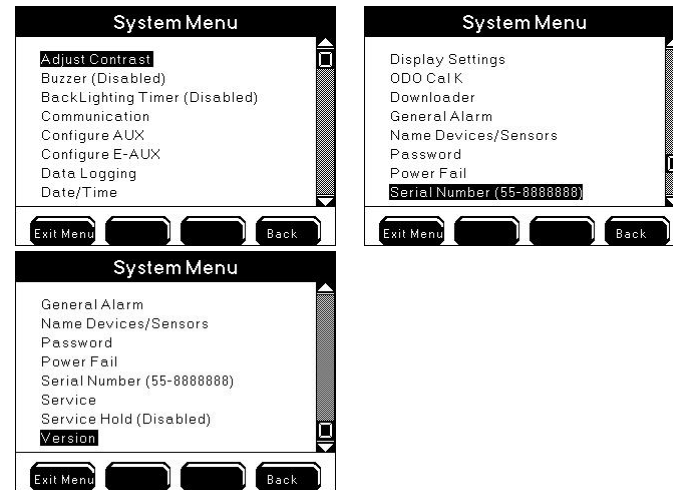
5500 **"ODO Cal K" submenu appears in 5500D instruments only.



Notes:

- See Appendix 3 "Menu Maps" for system defaults and ranges (where applicable) - starting on page 225.
- Menu configurations are saved to the instrument only after  is pressed and not when the change is made in the menu. If  is not pressed, the changes made to the configuration will not be saved. Exception - Date and time and clear data logs are updated immediately to the system; however, YSI recommends pressing  in this instance in order to save any other changes that may have been made to the configuration.

Adjust Contrast

Menus → System → Adjust Contrast

Use the Adjust Contrast menu to lighten or darken the display contrast.

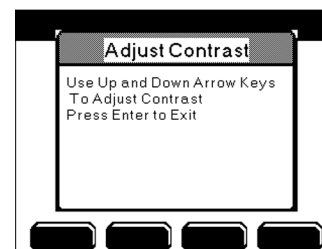

1. Enter Adjust Contrast Menu:
 Menu → System → Adjust Contrast
2. Use ▲ or ▼ to darken/lighten display.
3. Press ◀ to confirm new display contrast.
4. Press Exit Menu to save configuration and return to Run Screen.

Notes:

- The display contrast will adjust automatically based on the 5X00's internal temperature.
- Contrast adjustment cannot be performed using AquaManager.



Buzzer

Menu → System → Buzzer

The 5X00 has an audible buzzer that sounds when a general alarm condition occurs. The buzzer sounds after the alarm hold off period. The General Alarm must be enabled for the buzzer to sound. Use the Buzzer Menu to enable or disable the audible alarm.

When enabled, the buzzer will sound until one of the four bottom softkeys on the 5X00 front panel is pressed. From the Run Screen, press one of the following softkeys **Menu**, **Control**, **Msg's**, **Svc Hold** to reset the General Alarm. Resetting the General Alarm silences the buzzer, de-energizes any alarm relay(s), and stops any pending 5X00 email alarm messages. See *General Alarm - page 131 and Sensor Setup - page 150* for additional information.

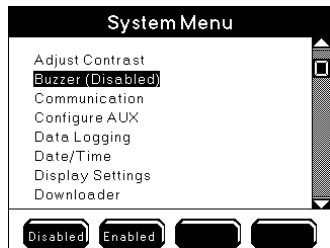

1. Enter Buzzer Menu
 Menu → System → Buzzer
2. Press Disabled or Enabled to turn the buzzer either off or on.
3. Press Exit Menu to save configuration and return to Run Screen.

BackLighting Timer

Menu → System → BackLight Timer

When the backlight timer is enabled, the backlight will turn on when any front panel key is pressed and then turn off after the user configured backlighting timer expires. If the backlight timer is disabled, the display backlight will not turn off.



1. Enter BackLight Timer menu
 Menu → System → BackLight Timer
2. Use ▲ and ▼ to scroll and highlight submenus.
3. Press ◀ to select the submenu you wish to change.
4. Enable and configure submenus.
5. After making desired changes, press Exit Menu to save configuration and return to Run Screen.

Communication

Menu → System → Communications

Select the communication method for AquaManager and/or 5X00 email alarming. Only 1 communication method can be used at a time. Hardware changes are required when the communication method is changed. See *Wire Communication Equipment - page 66*. Configure remote ethernet communication, network settings, and RS232 settings in the Communications menu.

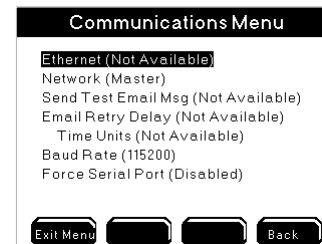

Note:



- AquaManager supports both communication methods.

Email Alarming

Email alarming can be configured 1 of 2 ways.

1. A 5X00 email is sent from the 5X00 serial to ethernet device - See *Ethernet* starting on page 92 for additional information.
2. An AquaManager email is sent from the PC running the AquaManager application. AquaManager Autopoller must be running. See *Chapter 5 AquaManager - page 197 and AquaManager online help* for additional AquaManager email alarming information.



*Ethernet connection requires access to an SMTP server accessible by the local network.

EMAIL ALARMING DISCLAIMER - There are many factors that can affect delivery of an email in a timely fashion. Certain SMTP email servers are more reliable than others. No email alarm message has guaranteed delivery. Use multiple email addresses and email forwarding as safe guards. Mechanisms, such as spam filters used by service providers, evolve constantly and can result in non-delivery of email messages. Verify with the service provider and/or network administrator to confirm that the 5X00 communication configuration ensures the most reliable delivery of alarm emails.

Below is a 5X00 DO Alarm Low email sent from a serial to ethernet device. As shown in the example, all of the alarm information is listed in the subject line. The user-configured device name is 'YSI Environmental'. The DO system does not have a user-configured name; therefore, the default system name, 'DO - 3', is included in the subject line.

From: myname@xxx-xxxx.com
 Sent: Mon, May 11, 2010 10:24 am
 To: myname@xxx-xxxx.com
 CC: hot49@xxxx.com
 Subject: 05/11/2010 10:23:29 AM YSI Environmental DO - 3 Alarm Low 77%Sat

Notes 5X00 alarm emails:

- 5X00 emails contain date, time, device name, system name, alarm condition, and the sensor reading in the Subject line of the email. When instrument and sensor names are not user configured, the email includes the serial number and default system name, i.e. "DO - 3".

- On a network, user configured instrument and sensor system names appear in the alarm emails for the master only. Slave alarm emails will report the 5X00 slave serial number and the default system names regardless if the names are user configured.
- Aux digital closed alarm is reported as 0.00; aux digital open alarm is reported as 1.00.
- Aux analog alarm emails are reported in 0.00 resolution regardless of the display format resolution.
- See *General Alarm*- page "General Alarm" on page 131 and *Set Points* - page 153 for important alarm configuration information.
- Emails are retransmitted based on the Email Retry Delay configuration - 100.
- Separate emails are sent for each alarm condition.
- 5X00 DO email alarms provide the %Sat value and do not provide mg/L value.
- 5X00 emails that say "Alarm Both" mean that both a high and low alarm condition have existed and the alarm has not been cleared by pressing a front panel key.
- 5X00 alarm emails are not transmitted during a service hold.
- 5X00 slave emails are sent to the configured email addresses in the master.
- At power up, the serial to ethernet device may take up to 2 minutes to initialize before sending alarm emails (if alarm condition exists).
- On a network, multiple alarm conditions may exist but only one alarm email is sent. Master alarm emails have priority over slave alarms. When multiple slave alarm conditions exist, it's possible that only one of many 5X00 slave alarms will be sent. Therefore, it is critical that all alarm emails are addressed locally by the user.



Below is an example of a 5X00 DO Alarm Low email sent from AquaManager. All of the information is in the body of the email and not the subject line.

YSI5X00 Alarm
 ysi environmental (node name in tree)
 54-2345567
 DO2 Low Alarm: 77

Notes AquaManager alarm emails:

- AquaManager emails are retransmitted based on the Email Retry Delay configuration - page 100.
- Multiple system alarms are included in one AquaManager email.
- AquaManager DO email alarms provide the %Sat value and not the mg/L value.
- For the AquaManager alarm email to function properly, it may be necessary to send a test email to each email address configured in the Email Alarm List in the Node Properties window. Test emails can be sent in the AquaManager Properties window under the Autopoller tab.

Ethernet



Menus → System → Communications → Ethernet

The serial to ethernet device speed and format are self configured at power up (TCP/IP connections). If the serial to ethernet device is not installed or is not installed properly, the ethernet menu will display (Not Available).

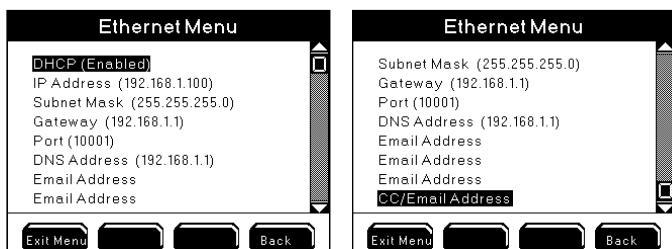

Notes:

- 5X00 email alarming from ethernet module requires access to an SMTP server accessible by the local network.
- Do not reconfigure internal serial to ethernet device settings.



1. Install serial to ethernet device - page 68.
2. The Ethernet icon  displays at the Run Screen when the serial to ethernet device is properly installed.
3. Enter Ethernet menu
 Menus → System → Communications → Ethernet
4. Use ▲ and ▼ to scroll and highlight submenus.
5. Press ← to select submenu.
6. Configure submenus as needed.
7. Press  to save configuration and return to Run Screen.

Notes:

- The CC/Email address must be configured when using 5X00 email alarming. Specific alarm system information will not be sent if the CC/Email address menu is not configured with a valid email address.
-  If Autopoller is being used for AquaManager email alarming on a TCP/IP connection, it is strongly recommended that the 5X00 email alarming using the serial to ethernet device be disabled. When the ethernet device sends email alarms, all Autopoller SMS communication is suspended. This could potentially delay any AquaManager alarm emails from being sent.
-  To disable the serial to ethernet device from sending alarms, clear all four

email addresses from the *Communication* → *Ethernet* menus. Clear the email addresses by using the “SpC” (space) key on the numeric keypad. Save changes at numeric keypad and press  to save configuration and return to Run Screen.

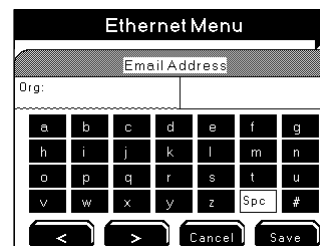

DHCP

Menus → System → Communications → Ethernet → DHCP

Enable DHCP if you are using the serial to ethernet device only for 5X00 email alarming and not for AquaManager remote TCP/IP access.

Notes:

- When DHCP is enabled, the 5X00 IP address is not updated at the IP address menu.
- With DHCP enabled, the serial to ethernet device acquires SMTP and DNS addresses during initialization.
-  AquaManager requires a static IP address; therefore, DHCP must be disabled when using AquaManager. Consult the network administrator to obtain a static IP address.
- Power cycle the 5X00 if DHCP configuration changes from disabled to enabled..

IP Address

Menus → System → Communications → Ethernet → IP Address

The IP address can only be configured when DHCP is disabled.

Notes:

-  AquaManager users should program the IP Address either by force serial port using AquaManager or locally at the 5X00. Poll node using RS232 communication . Next upload configuration information including: static IP, port, subnet, and gateway addresses.

- When DHCP is enabled, the IP address is not updated at the IP address menu.
- Power cycle the 5X00 whenever a new IP address is configured.
- Numbers between 0-255 are valid for each of the four (4) IP Address fields.

Subnet Mask

Menus → System → Communications → Ethernet → Subnet Mask

A Subnet mask address can only be configured when DHCP is disabled. The subnet mask number helps to define the relationship between the host (computers, routers, switches, etc.) and the rest of the network. Consult the network administrator when configuring this menu.

Notes:

- When DHCP is enabled, the Subnet Mask address is not updated at the Subnet Mask menu.
- AquaManager users should program the Subnet mask either by force serial port using AquaManager or locally at the 5X00. Poll node using RS232 communication . Next upload configuration information including: static IP, port, subnet, and gateway addresses.
- Numbers between 0-255 are valid for each of the four (4) Subnet Mask IP Address fields.

Gateway

Menus → System → Communications → Ethernet → Gateway

The Gateway address can only be configured when DHCP is disabled. A gateway IP refers to a device on a network which sends local network traffic to other networks. Consult the network administrator when configuring this menu.

Notes:

- When DHCP is enabled, the Gateway address is not updated at the Gateway menu.
- AquaManager users should program the Gateway address either by force serial port using AquaManager or locally at the 5X00. Poll node using RS232 communication . Next upload configuration information including: static IP, port, subnet, and gateway addresses.
- Numbers between 0-255 are valid for each of the four (4) Gateway IP Address fields.

Port

Menus → System → Communications → Ethernet → Port

The default port number for the ethernet module is 10001. Consult the network administrator when configuring this menu.

Note:



- AquaManager users should program the port number either by force serial port using AquaManager or locally at the 5X00. Poll node using RS232 communication . Next upload configuration information including: static IP, port, subnet, and gateway addresses.

DNS Address

Menus → System → Communications → Ethernet → DNS

Domain Name Service (DNS) refers to the server, or workstation, used to convert domain names into IP addresses.

Notes:

- With DHCP enabled, the serial to ethernet device will acquire SMTP and DNS addresses during initialization.
- When DHCP is enabled, the DNS address is not updated at the IP address menu.
- Numbers between 0-255 are valid for each of the four (4) DNS IP Address fields.





Email Addresses

Menus → System → Communications → Ethernet → Email Address
 → Email Address
 → Email Address
 → CC/Email Address

Up to four email addresses can be configured for 5X00 emails. At a minimum, the first email address and the CC/email address must be configured. **If the CC/email address is not configured, 5X00 email alarms will contain no alarm information.** The email 'from' address will be the email address entered in the first *Email Address* menu.

Notes:

- See *Send Test Email Msg* - 99 to verify proper configuration of ethernet menus.
- On a network, both master and slave alarm emails are sent to the configured email addresses in the master.
- Test the alarm email delivery by creating an alarm condition at the 5X00 and verify the email(s) is received.

- The CC/Email address must be configured when using 5X00 email alarming. Specific alarm system information will not be sent if the CC/Email address menu is not configured with a valid email address.
-  - Use AquaManager to easily configure email addresses using the PC keyboard. See AquaManager on line help for additional information.
-  - If Autopoller is being used for AquaManager email alarming on a TCP/IP connection, it is strongly recommended that the 5X00 email alarming using the serial to ethernet device be disabled. When the ethernet device sends email alarms, all Autopoller SMS communication is suspended. This could potentially delay any AquaManager alarm emails from being sent.
-  - To disable the serial to ethernet device from sending alarms, clear all four email addresses from the *Communication* → *Ethernet* menus. Clear the email addresses by using the “Spc” (space) key on the numeric keypad. Save change at numeric keypad and press  to save configuration and return to Run Screen.

Ethernet Module Error Message

At power up, the serial to ethernet device will generate an error message if it cannot properly handshake with the 5X00 hardware. If this error occurs, communication (AquaManager and 5X00 alarm emails) will not work via TCP/IP. The error could be a result of incorrect serial to ethernet device installation or a faulty ethernet device. The error message will appear in the event log.

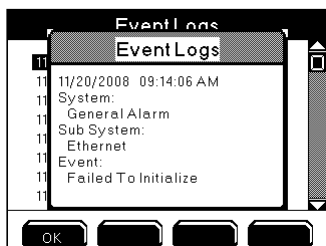

SMS Messaging with Ethernet Module

SMS (Short Message Service) or text messaging is a service for sending messages to your cell phone or mobile device. To use SMS messaging, enter the email address in the **Menus** → **System** → **Communications** → **Ethernet** → **Email address**. See *Appendix 6 SMS* - page 255 for a list of cellular and mobile companies that support sending text messages.

Node Network

Menus → **System** → **Communications** → **Network**





A node network refers to either one stand alone master node and/or one master node and up to 31 configured and wired slave nodes. Node networks with at least one slave are physically connected using RS485 protocol see 60 for additional information. Only the master node is configured for serial or ethernet module communication.

On a network with at least one slave the master continuously queries enabled slaves on the network. The master is the access point for the entire network. This includes AquaManager communication and sending of 5200A/5X00 alarm emails. Slave nodes must be configured with a slave address.

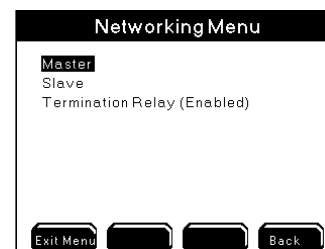
Note:

-  - Multiple node networks communicating via direct connect (RS232) require separate PC COM ports for simultaneous AquaManager mapping and auto-polling.





1. Wire 5X00 network - page 60.
2. Enter Network menu
Menus → **System** → **Communications** → **Network**
3. Press  and  to scroll and highlight submenus.
4. For master node: Press  at master submenu.
5. For all slave nodes: Press  at slave submenu. Configure a slave address.

 Note:

- The slave address appears as the slave subnode at node properties.
 - Configure slave addresses with numbers of 1 through 31.
6. Disable the Termination Relay on all devices except the first and last device on the network. **Menus** → **System** → **Communications** → **Network** → **Termination Relay**.

7. Verify that the Termination Relay is enabled on the first and last device on the network.

8. For master node: Press  at master submenu. At assign slaves menu, select the slave address configured in step 5 above. Press enter. Enable one slave at a time using   softkeys.



9. Press  to save configuration and return to Run Screen.
 10. Each slave should be tested one by one. Insert network termination strip and apply power to the master and the last physical device on the network. If the master is not the first or last physical device on the network, apply power and insert network terminal strip on the master and on the first and last physical devices on the network. Refer to network wiring instructions for additional information - page 60. Testing for proper wiring and configuration can be done one of two ways:

A. After performing step 9, wait at least 30 seconds and then reenter the Communication Master submenu. If serial number of the slave is displayed next to the slave address number, the communication network is wired and configured correctly.



OR



B. After performing step 9, wait at least 30 seconds and then poll the slave node using Aqua Manager. Follow AquaManager online Help to Insert node into AquaManager network. AquaManager will obtain node configuration, current data and any logs if the node network is wired and configured correctly.

Notes:

- An Event and General Alarm (if enabled) will occur if, after ten queries, an enabled slave does not respond to the Master.

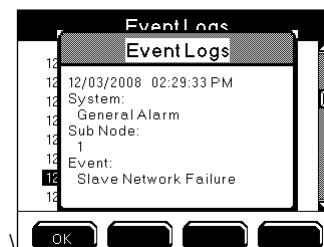

- Configuring a 5X00 as a Master overrides any slave configuration that had been previously saved.
- Slave alarms (slave alarm at master and 5X00 email alarms) will not occur if slave node serial number is not recognized at master node at steps 10. A or 10. B above.

Termination Relay

Menus → System → Communications → Network → Termination Relay

The termination relay must be enabled on the first and last 5X00 on a network. All other devices should have the termination relay disabled.

Send Test Email Msg

Menus → System → Communications → Send Test Email Msg

Send a test email to verify proper configuration of ethernet menus. If necessary confirm all ethernet menus configuration starting on page 92. Test emails are only transmitted from configured master 5X00s.

Notes:

- Test emails are sent to all configured email address.
- Exit to Run Screen is required before the test email is sent.

Example of a 5X00 test email sent from ethernet device:

From: myname@xxx-xxxx.com
 Sent: Wed, Feb 04, 2010 3:49 pm
 To: myname@xxx-xxxx.com
 CC: sweet49@xxxx.com
 Subject: 02/04/10 03:50:05 PM YSI5X00 Email Alarm Test Message

Email Retry Delay

Menus → System → Communications → Email Retry Delay

Configure the Email Retry Delay for the time interval that emails should be retransmitted after the initial alarm email is sent. The initial alarm email is sent immediately after the general alarm hold off time or after the aux hold off time. Emails will be retransmitted until one of the front panel softkeys is pressed, regardless if the alarm condition still exists.

Notes:

- On a network, emails are retransmitted according to the slave retry delay configuration of the slave in alarm and not the master's email retry delay configuration. Please note, a slave Email Retry Delay menu will display (Not available) because of its slave configuration; however, this feature is available and has a default value of 15 minutes that can be configured by the user.
- The Retry Delay should be configured at intervals ≥ 15 minutes.
- AquaManager alarm emails are retransmitted based on 5X00 slave(s) and master email retry delay configuration.

Baud Rate RS232

Menus → System → Communications → Baud Rate

Configure the Baud rate (for RS232 connections only) in the 5X00 to match the baud rate configured in AquaManager. Use the default rate of 115200 for fastest communication speed.

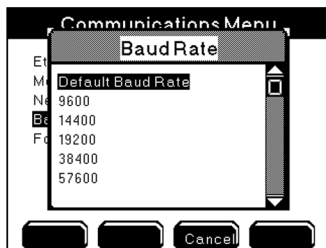

1. Enter Network menu
Menus → System → Communications → Network → Baud Rate
2. Press ▲ or ▼ to scroll and highlight a selection.
3. Press ← to confirm selection.
4. Press **Exit Menu** to save configuration and return to Run Screen.

Force Serial Port

Menus → System → Communications → Force Serial Port

Enable the Force Serial Port when the 5X00 is communicating via RS232 (direct) to a PC and when the 5X00 has a serial to ethernet device.

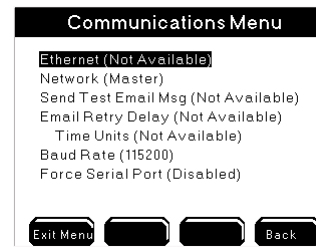

1. Wire RS232 connection - page 66.
2. Enter Communications menu
Menus → System → Communications → Force Serial Port
3. Use the **Disabled** **Enabled** softkeys to configure off or on.
4. Press **Exit Menu** to save configuration and return to Run Screen.

Notes:

- RS232 connection is required to upload firmware using the Firmware Updater.
- The RS232 icon  blinks at the Run Screen when in Force Serial Port mode.

Non-Networked (Stand Alone) 5X00s

Non-networked (stand alone) 5X00s must have the termination relay enabled. In addition, non-networked (stand alone) 5X00s must be configured as a master in the System Communication menu with no slave nodes enabled.

Configure AUX

Menus → System → Configure Aux 1-6

The 5X00 has six auxiliary (Aux) inputs. Aux inputs 1, 2, 3, 4, 5, and 6 can be configured for digital or analog (0-1V,DC 0-5VDC, or 4-20 mA) inputs. In addition, Aux 3, 4, 5, and 6 can be configured with a temperature sensor. Configure suffix, minimum (Min), maximum (Max), Input Scale Min, Input Scale Max and display format menus for non temperature analog inputs. To configure set points, control, alarms and relays see specific sensor set up menus. See Aux digital sensor set up - page 165. See Aux analog (non temperature) sensor set up - page 166. See Aux and ODO temperature sensor set up - page 168. Configure Aux menus vary based on the configured Input Type.

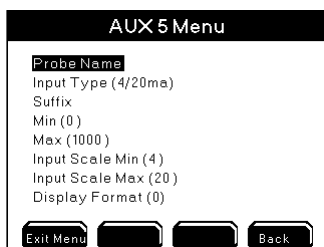
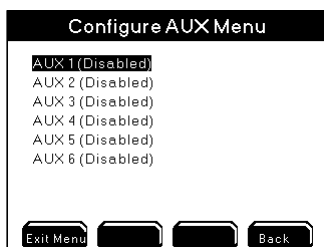

5400 Configure Aux 5 menu
(no Temp Source menu)

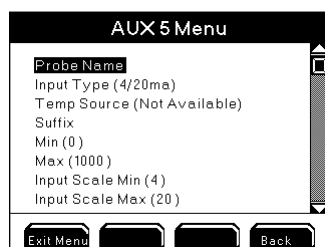

5500 Configure Aux 5 menu
(Temp Source menu will be available when Temperature Input Type configured)

Probe Name

Menus → System → Configure Aux →Aux 1-6→Probe Name

Use the alpha/numeric keypad to name aux inputs. Configured name(s) appear throughout menus and at Run Screen - figure 4.7- page 106.

Note:

- Aux names can also be configured at Menus → System → Name Devices/ Sensors.

Input Type

Menus → System → Configure Aux →Aux 1-6→Input Type →Digital
 →0-1v
 →0-5v
 →4/20ma
 →Aux 3-6→Input Type →Temperature

Select the input type for the device(s) wired to aux system(s). Aux Sensor Setup menu selections are based on the aux input type configured at system>Configure Aux menu. All input types are discussed in the following sections.

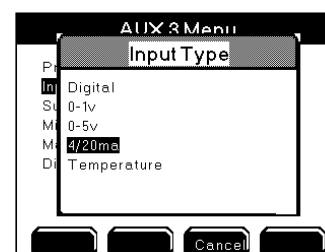

Digital

Menus → System → Configure Aux →Aux 1-6→Input Type→Digital

Use digital input when wiring an external device to control or alarm when the contacts of an external switch open or close. A common application would be to detect high or low water levels using a float switch.

Notes:

- Suffix, Min, Max, and Display Format are not available for digital inputs.
- In the 5X00 sensor log, aux digital “closed” is logged as Aux 0.00. Aux digital “open” is logged as Aux 1.00.

Directions to configure Digital device at Configure Aux menu:

1. Wire aux digital devices - page 57.
2. Enter Aux menu
 Menus → System → Configure Aux →Aux 1-6
3. Use ▲ and ▼ to scroll and highlight submenus.
4. Press ← to select.
5. Configure digital input type and name.
6. Press Exit Menu to save configuration and return to Run Screen.

Display Format

Menus → System → Configure Aux → Aux 1-6 → Display Format

Configure the Display format (0, 0.0, or 0.00) based on the resolution to be displayed at the Run Screen.

Example - when using a total dissolved gas pressure sensor, configure the display format as 0.0 - figure 4.7 below.

In the below screen shot, the Run Screen is displaying aux name “TGP” suffix “mmHg,” with display format “0.0”. The display value represents an input of 1.875 volts with 0-5VDC analog aux configuration. The min value = “-400”. The max value = “+400.” The control/alarm low is “-50.” Alarms are enabled for this aux input.

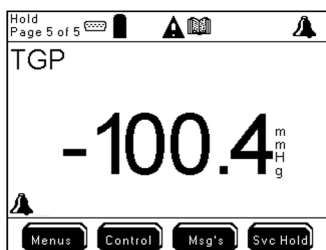

figure 4.7

Notes:

- Values displayed at the run screen are based on display format resolution configuration. Example - if the display format is 0.0 and the min value input is 1.88, then 1.9 will be displayed at the run screen.
- 5X00 aux analog (non temp) sensor log records 0.00 resolution regardless of the selected resolution in the aux analog display format configuration.

Directions to configure Aux analog (non temp) Configure Aux menu:

1. Wire aux analog devices - page 57.
2. Enter Aux menu
 Menus → System → Configure Aux → Aux 1-6
3. Use ▲ and ▼ to scroll and highlight submenus.
4. Press ↵ to select.
5. Press **Exit Menu** to save configuration.
6. Go to Sensor Setup Menus → Sensor Setup Aux 1-6 - page 166. to en-

able and configure set points, control, alarm, relays, and hold off time.

7. Press **Exit Menu** to save configuration.

Note:

- The alarm low value must be ≥ the min value. The alarm high value must be ≤ the max value.

Analog Temperature (Aux 3, 4, 5 and 6)

Menus → System → Configure Aux → Aux 3-6 → Input Type → Temperature

Aux 3, 4, 5 and 6 can be wired and configured for a temperature sensor. Temperature systems are configured differently for 5400 and 5500D instruments. The differences are explained below.

5400 5400 ~ Aux configured temperature systems can be configured as stand alone independent temperature systems. In addition, Aux temperature systems can be configured as the temperature source for any of the four DO systems. Configure the DO temperature source in the DO sensor set up menu - page 173.

5500 5500D-01, 5500D-02 and 5500D-04 ~ Aux configured temperature systems can only be configured as stand alone independent temperature systems and cannot be assigned as a temperature compensation source for any DO system. The DO system temperature compensation value is always taken from the temperature sensor in the ODO probe. Temperature systems can be configured using the ODO temperature value or the Aux 3, 4, 5 and/or 6 temperature value. Configure the temperature system source at the **Menus → System → Configure Aux → Temp Source** menu. Configure “Aux Port” if the temperature system is to be driven by the input value of a temperature sensor wired to aux 3, 4, 5 or 6. Configure “ODO Probe” if the temperature system is to be driven by the ODO probe temperature sensor value.

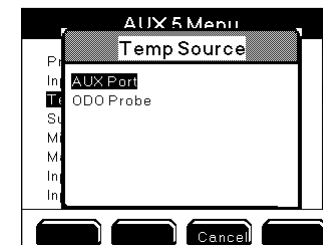
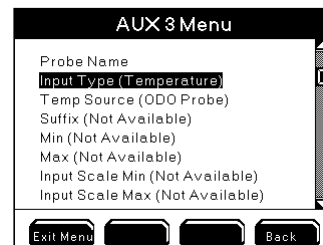

Directions to configure Aux temperature Configure Aux menu:

1. Wire temperature sensors - page 52.

2. Enter Aux menu
 Menu → System → Configure Aux → Aux 3-6
3. Configure temperature input type and name.
4. Use ▲ ▼ to scroll and highlight submenus.
5. Press ◀ to select.
6. Press **Exit Menu** to save settings and return to Run Screen.
7. Go to Sensor Setup Menus → Sensor Setup Temperature for Aux 3-6 and ODO - 168 to configure temperature system.
8. Press **Exit Menu** to save settings and return to Run Screen.

Note:

- The Sensor Setup menu - page 150 is automatically enabled when an aux channel is configured for temperature.



Configure E-AUX

NEW Menu → System → Configure E-Aux 1-8

All 5X00 instruments have eight E-Aux systems. E-Aux systems are sometimes referred to as virtual system because unlike Aux systems which use six onboard (Aux) inputs for wiring input devices, E-Aux systems use inputs that are wired to a networked IOEM. 5X00 E-Aux systems mimic aux systems but use a remote IOEM wiring location for the actual input. E-Aux inputs 1-8 can be configured for digital, analog (0-1V, DC 0-5VDC, or 4-20 mA) or temperature inputs. System → **Configure E-Aux 1-8 menu selections change based on input type selection.** Configure suffix, minimum (Min), maximum (Max), Input Scale Min, Input Scale Max and display format menus for non temperature analog inputs. To configure setpoints, control, alarms and relays see specific sensor setup menus for configured input type For E-Aux Analog Sensor Setup - page 166. For E-Aux Temperature Sensor Setup - page 168. For E-Aux Digital Sensor Setup - page 165.

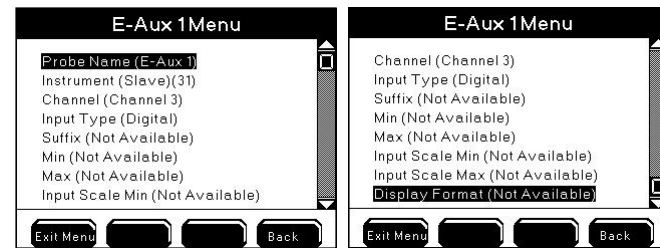

Notes:

- Configure E-Aux systems to monitor, control and/or alarm IOEM inputs the same way 5X00 aux sensor systems function.
- E-Aux systems have data and event logging functionality.
- E-Aux system datalogs are not visible at the instrument.
- At the Run Screen “Offline” display at an E-Aux system means the configured IOEM input value that the associated 5X00 instrument E-Aux system is configured for is not recognized. An example - if an IOEM channel mode is configured to digital and the input signal is a 0-1V signal, the reading at the run screen will be “Offline”;

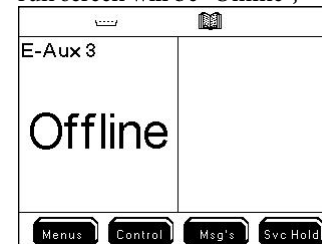

Probe Name

Menu → System → Configure E-Aux → E-Aux 1-8 → Probe Name

Use the alpha/numeric keypad to name E-Aux inputs. Configured name(s) appear throughout menus and at Run Screen - figure 4.7- page 106.

Note:

- E-Aux names can also be configured at Menu → System → Name Devices/Sensors > Name E-Aux > E-Aux 1-8.

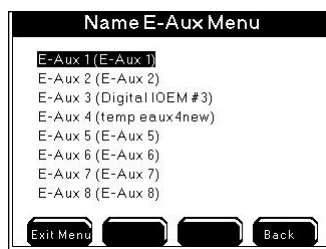

Instrument

Menus → System → Configure E-Aux → E-Aux 1-8 → Instrument → Device Address menu opens

Select the IOEM slave device address whose input will be used as an input signal for this E-Aux system.

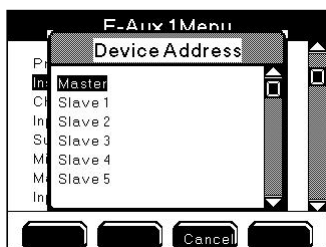

1. Use ▲ ▼ to scroll and highlight IOEM Slave device address.
2. Press ← to select.
3. Press **Exit Menu** to save settings and return to Run Screen.

Notes:

- The Device Address menu displays a generic list of instruments being Master and Slaves 1-31.
- The Local Machine user configured name is displayed if the local machine is configured.
- See page 86 for local versus remote instrument description.
- The Device Address menu will always display a Master and slaves 1-31 regardless of the actual number of slaves wired to the node network.

Channel

Menus → System → Configure E-Aux → E-Aux 1-8 → Channel → Channel menu opens

Select the IOEM channel whose wired input location will be used as an input signal for this E-Aux system.

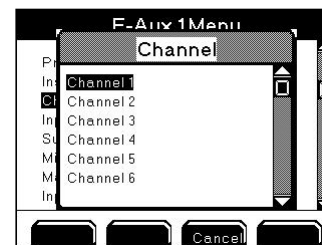

1. Use ▲ ▼ to scroll and highlight IOEM channels.
2. Press ← to select.
3. Press **Exit Menu** to save settings and return to Run Screen.

Notes:

- The Channel menu displays a generic list of instruments being Channel 1-8.
- The Channel menu will always display Channels 1-8 regardless if the IOEM device selected is an IOEM-4 which has only 4 channels and not 8.
- IOEM channel modes can only be configured using AquaManager. See AquaManager online help for directions to configure IOEM channel input mode (digital, 0-1V, 0-5V, 4mA-20mA, temperature);

Input Type

Menus → System → Configure E-Aux → E-Aux 1-8 → Input Type → Digital

- 0-1v
- 0-5v
- 4/20ma
- Temperature

Select the input type for the device(s) wired to IOEM channel(s). E-Aux Sensor Setup menu selections are based on the E-Aux input type configured at system>E-Aux menu. Input types are discussed in the following sections.

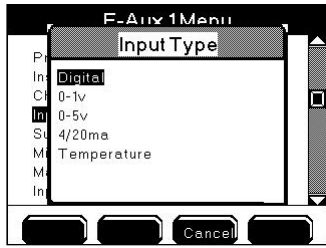

Digital

Menus → System → Configure E-Aux → E-Aux 1-8 → Input Type → Digital

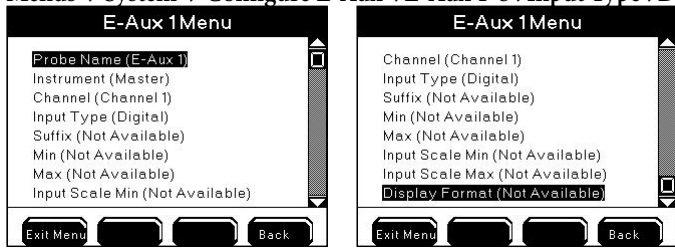

Use digital input when wiring an external device to an IOEM channel that will control or alarm when the contacts of an external switch open or close. A common application would be to detect high or low water levels using a float switch.

Notes:

- Suffix, Min, Max, and Display Format are not available for digital inputs.
- In the 5X00 sensor log, aux digital “closed” is logged as Aux 0.00. Aux digital “open” is logged as Aux 1.00.
- IOEM input channel modes can only be configured using AquaManager. See AquaManager online help for directions to configure IOEM channel input mode (digital, 0-1V, 0-5V, 4mA-20mA, temperature);

Configure E-Aux Digital - Configure E-Aux system menu:

1. Wire E-aux digital devices - see *IOEM Safety and Installation Guide*>Chapter 3 *Installation and Wiring*>*IOEM input configuration*>*Wire digital input*.
2. Refer to and follow directions at *IOEM Safety and Installation Guide*>Chapter 4>*Quick Start - IOEM Configuration* to confirm correct network connectivity;
3. Follow directions in the Quick Start section to configure IOEM channel mode to digital.
4. Enter E-Aux menu

Menus → System → Configure E-Aux → E-Aux 1-8

5. Use ▲ and ▼ to scroll and select submenus.
6. Press ↵ to select.
7. Configure input type to digital - page 111, name - page 109, instrument - page 110 and channel - page 111.
8. Press **Exit Menu** to save configuration and return to Run Screen.
9. Go to Sensor Setup Menus → Sensor Setup E-Aux 1-8 - page 165 to enable and configure control/alarm on condition, control/alarm relay, and hold off time.
10. Press **Exit Menu** to save configuration.

Analog

0-1VDC and 0-5VDC and 4/20mA

Menus → System → Configure E-Aux → E-Aux 1-9 → Input Type → 0-1V
→ 0-5V
→ 4/20mA

Select the analog input type based on the signal being sent from the device wired at the IOEM channel.

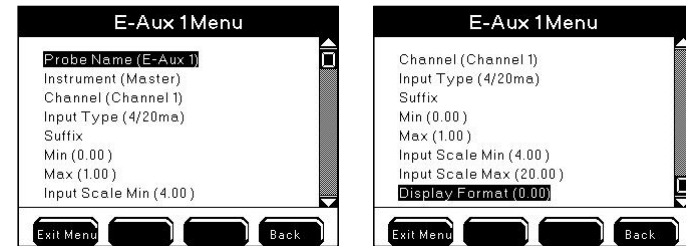

Notes:

- It is normal to hear an on-board relay “click” when switching to or from the 4/20ma E-aux input type.
- Analog systems will not monitor, control, or alarm properly if a device that operates outside the configured analog range is installed and configured.

Suffix

Menus → System → Configure E-Aux → E-Aux 1-8 → Suffix

Enter the Suffix (up to 4 characters) to describe the input type or units. The suffix is displayed at the Run Screen. The suffix is typically used to describe the input signal type.

Example - when using a total dissolved gas pressure sensor “mmHg” could be used as a suffix for measuring TGP (total dissolved gas pressure) - figure 4.7 - page 115.

Min and Max values

Menus → System → Configure E-Aux →E-Aux 1-8 →Min
→Max

Min and Max values are user defined. The range is -10000 to 10000. Min and Max values scale the display output value. The min and max values may be configured to correspond to the minimum input level (i.e. 0VDC or 4mA) and maximum input level (i.e. 1VDC, 5VDC, or 20mA). The Min value must be less than Max value.

Example - when using a total dissolved gas pressure sensor (0-5VDC input type) enter -400 for min value. The 5X00 will display “-400” when the input value is 0VDC. Configure the max value to correspond to the maximum input value as +400. The 5X00 will display “400” when input value is 5VDC.

Notes:

- The 5X00 will monitor and data log based on the “min” and “max” voltage or current signal.
- To enter negative values, type the whole number then select “-” on the numeric keypad.
- Whenever min and/or max values are changed, go to **Menus → System → Sensor Setup → E-Aux 1-6 → Control Low and Control High** menus to verify control/alarm values are correct for the application.

Input Scale Min and Max values

Menus → System → Configure E-Aux →E-Aux 1-8 →Input Scale Min
→Input Scale Max

Input scaling allows a way to view data within a specific input range of the input type (0-1v, 0-5v, 420/ma) in greater resolution. In the below example 0-1v is the input type and display format = 0. The configured Min value is 0, and the configured Max value is 1000. The input scale Min is .25 and the input scale Max is .75. (The user wants to only view data within this specific range). In the below example an input value of .25v = a display and datalog value of 0. An input value of .50v = a display value and datalog value of 1000.

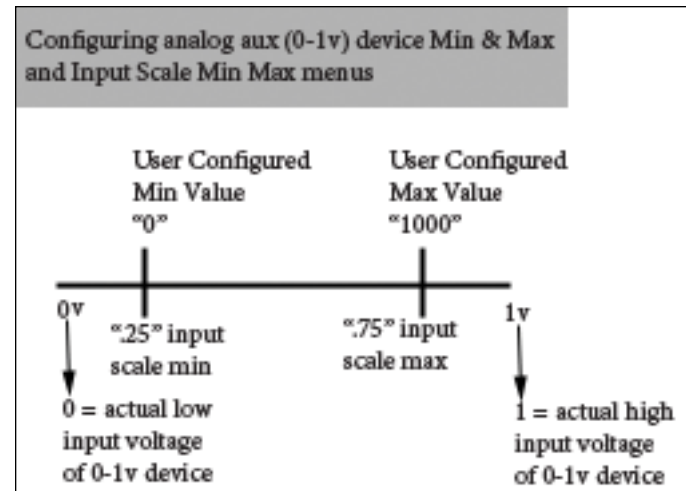

Display Format

Menus → System → Configure E-Aux →E-Aux 1-8→Display Format

Configure the Display format (0, 0.0, or 0.00) based on the resolution to be displayed at the Run Screen.

Example - when using a total dissolved gas pressure sensor, configure the display format as 0.0 - figure 4.7 below.

In the below screen shot, the Run Screen is displaying aux name “TGP” suffix “mmHg,” with display format “0.0”. The display value represents an input of 1.875 volts with 0-5VDC analog aux configuration. The min value = “-400”. The max value = “+400.” The control/alarm low is “-50.” Alarms are enabled for this aux input.

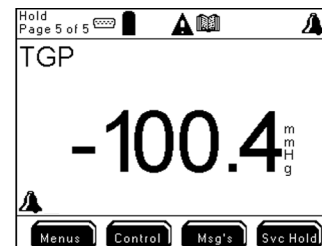

figure 4.7



Notes:

- Values displayed at the run screen are based on display format resolution configuration. Example - if the display format is 0.0 and the min value input is 1.88, then 1.9 will be displayed at the run screen.
- 5X00 aux analog (non temp) sensor log records 0.00 resolution regardless of the selected resolution in the aux analog display format configuration.

Configure E-Aux analog - Configure E-Aux system menu:

1. Wire E-Aux analog device - see *IOEM Safety and Installation Guide>Chapter 3 Installation and Wiring>IOEM input configuration>Wire analog input.*
2. Refer to and follow directions at *IOEM Safety and Installation Guide>Chapter 4>Quick Start - IOEM Configuration* to confirm correct network connectivity;
3. Follow directions in the Quick Start section to configure IOEM channel mode to 0-1v, 0-5v or 4/20mA.
4. Enter E-Aux menu

Menus → System → Configure E-Aux →E-Aux 1-8

5. Use ▲ and ▼ to scroll and highlight submenus to configure.
6. Press ◀ to select.
7. Configure Analog system name - page 109, instrument - page 110, channel - page 111, input type - page 111, suffix - page 113, min/max - page 114, scale min/scale max -page 114and display format - page 115menus. E-Aux submenus configuration is described in the above sections.
8. Press  to save configuration.
9. Go to Sensor Setup Menus → Sensor Setup E-Aux 1-8 - page 166 to enable and configure set points, control, alarm, relays, and hold off time.
10. Press  to save configuration.

Note:

- The alarm low value must be ≥ the min value. The alarm high value must be ≤ the max value.

Temperature

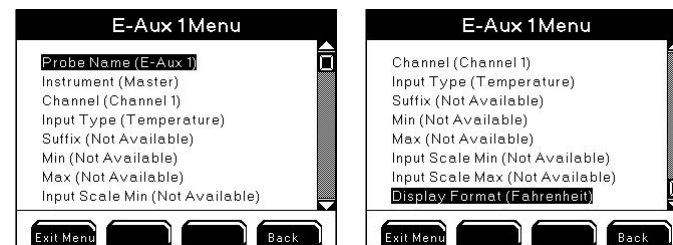

Menus → System → Configure E-Aux →E-Aux 3-6→Input Type→Temperature



Configure E-Aux temperature Configure E-Aux system menu:

1. Wire temperature device - see *IOEM Safety and Installation Guide>Chapter 3 Installation and Wiring>IOEM input configuration>Wire temperature input.*
2. Refer to and follow directions at *IOEM Safety and Installation Guide>Chapter 4>Quick Start - IOEM Configuration* to confirm correct network connectivity;
3. Follow directions in the Quick Start section to configure IOEM channel mode to temperature.
4. Enter E-Aux menu

Menus → System → Configure E-Aux →E-Aux 1-8

5. Use ▲ and ▼ to scroll and highlight submenus to configure.
6. Press ◀ to select.
7. Configure name- see page 109 instrument - page 110, channel - page 111, input type - page 111 and display format (F° or C°).
8. Press  to save configuration.
9. Go to Sensor Setup Menus → Sensor Setup E-Aux 1-8 - page 168 to enable and configure set points, control, alarm, relays, and hold off time.
10. Press  to save configuration.



Data Logging

Menus → System →Data Logging

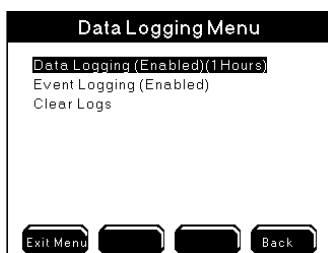
The 5X00 saves information in calibration, sensor, and event logs. Press  at the Run Screen to view the 25 most recent records for each log. The 5X00 sensor log stores 2000 records. The calibration log can store 500 records. And the event log stores 1250 records. Once a 5X00 log is full, it will begin overwriting the oldest records with new records (data wrapping).



Notes:

-  Use AquaManager to store and analyze 5X00 logs. To avoid gaps in data, use polling intervals based on the user defined data logging configuration. Set the data log interval so that analyzing the data is meaningful.
-  AquaManager users can view Configuration events in the Configuration log. Configuration events are created when certain 5X00 configuration changes are made. The configuration log is not accessible at the 5X00. See *AquaManager Online Help* for additional information.

Data Logging

Menus → System → Data Logging → Data Logging



The 5X00 sensor log stores records for sensors and aux systems. Sensor logs are time and date stamped based on the user configured logging interval (10-255 seconds or 1-255 minutes or hours).

1. Enter Data Logging menu
Menus → System → Data Logging → Data Logging
2. Use ▲ ▼ to scroll and highlight submenus.
3. Press ↵ to select.
4. Enable and configure submenus.
5. Press  to save setting and return to Run Screen.

Press  to view the 25 most recent sensor logs

Notes:

- Aux digital “closed” is logged as Aux 0.00. Aux digital “open” is logged as Aux 1.00.
- The 5X00 sensor log records 0.00 resolution for aux analog inputs regardless of the selected display format.
- DO values are stored in mg/l & %Sat regardless of selected display format.

- Sensor logs record the default system name and not the user configured system name.
- Aux temperature values are not accessible at the 5X00. Temperature values can only be obtained using AquaManager. Values will be shown in the AquaManager data log in °C regardless of the selected display format.
- E-Aux system datalogs are not visible at the instrument. E-Aux system datalogs are only viewable using AquaManager.
- Aux Temperature values are only available and stored for temperature systems assigned to a DO system. These values are not available at the 5400. The values can only be viewed with AquaManager.
- Temperature values are available for either a ODO temperature sensor or a stand alone aux temperature systems. These values are not available at the 5500. The values can only be viewed with AquaManager.
- Changes to the data logging interval take effect after the expiration of the interval being changed. Example - if the interval is changed from one hour to one minute, one minute logging will begin after the expiration of the current one hour interval. Power cycle the 5X00 to make a change to the data logging interval occur immediately.
- **Menu configurations are saved to the system by pressing  to return to the Run Screen and not when the change is made in the menu. Exception - Date and time and clear data logs are updated immediately to the system, not when  is pressed.**
- The sensor log contains values for all sensor and aux systems regardless if the system is disabled.
- 5X00 sensor log values for disabled systems and systems without sensors are not valid.

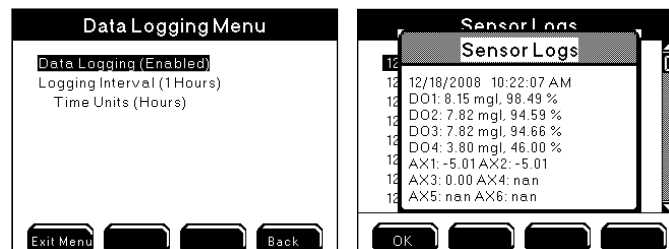

In the above sensor log screen shot Aux 3 is assigned as temperature for DO 1. DO 4 and Aux 1, 2, 4, 5, & 6 are disabled.

Event Logging

Menus → System → Data Logging → Event Logging

Control, Alarm, and Timer relays assigned to 5X00 systems create events when they turn on and off. In addition, AC power failures, ethernet device error messages, and slave network failures create events. These events are stored in the Event Log. Event logs identify the 5X00 system, are time and date stamped, and record relay action (“on” or “off”).

1. Enter Event Logging menu
 Menus → System → Data Logging → Event Logging
2. Use ▲ ▼ to scroll and highlight submenus.
3. Press ↵ to select.
4. Press Disabled Enabled to turn off or on.
5. Press Exit Menu to save setting and return to Run Screen.

Press Msg's to view 25 most recent event logs.

Press Control to view active (“on”) non timer events. See Control Menu - 192 for additional information.

Notes:

- The General Alarm does not create an event whether a general alarm relay is enabled or not.
- Events are not recorded when relays de-energize due to system-wide events. System-wide events include calibration, Svr Hold, factory resets, power cycle, 30 second sensor system reset, relay test, and disabling systems.
- Event logs record the default system name not user configured system name.
- Event logs do not record relay number or user configured relay name.
- Aux digital events will never display “alarm” regardless if alarms are enabled, see below screen shot on right.
- E-Aux system event logs are stored at the local instrument whose E-Aux system is being used and not at the device whose output is creating the event. For example - if an IOEM channel 2, whose slave address is 4, is configured as an E-Aux temperature input for a 5200A (slave 14), and a low temperature control relay output for this slave 14 is configured to a 5500 (master), the 5200A (slave 14) and not the master 5500 records the low temperature control events.

Clear Logs

Menus → System → Data Logging → Clear Logs

Use the Clear Log option to permanently delete all event and/or sensor log records from the 5X00.

 Before permanently deleting sensor and event logs, poll all data using AquaManager. AquaManager will store all logs in PC database.

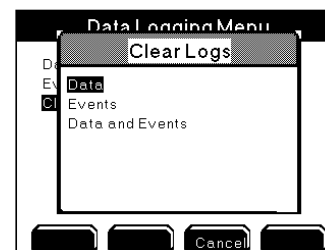

1. Enter Clear Log menu
 Menus → System → Data Logging → Clear Logs
2. Use ▲ and ▼ to scroll submenu.
3. Press ↵ to select.
4. The instrument will prompt, “Are You Sure?” Press one of the following softkeys to confirm: Yes No Cancel.
5. Selecting “Yes” deletes logs after approximately three seconds.
6. Selecting “No” or “Cancel” does not delete logs and returns to the Data Logging menu.
7. Press Exit Menu to save setting and return to Run Screen.

 Notes:

- Logs cannot be deleted from the 5X00 instrument using AquaManager.
- Calibration and Configuration logs cannot be cleared from 5X00.
- Clear data logs are updated immediately to the system and not when Exit Menu is pressed. YSI recommends pressing Exit Menu in this instance in order to save any other changes that may have been made to the configuration. Exception -

Date/Time

Menus → System → Date/Time

It is important to configure the correct date and time in the 5X00. Four 10-event daily timers and four feed timer run based on the 5X00 date and time. Logs record events based on the 5X00 clock. Date and time display formats are user defined.

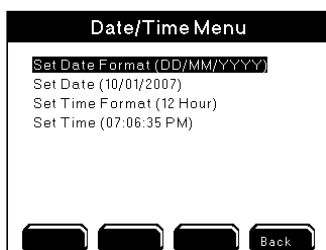

1. Enter Date/Time menu
Menus → System → Date/Time
2. Verify 5X00 current date and time.
3. If necessary, use ▲ and ▼ to scroll and highlight submenus.
4. Press ← to select.
5. Configure submenus.
6. Press Exit Menu to save setting and return to Run Screen or press Back to System menu.

Notes:

- Changes to Date and Time menus take place immediately and are saved prior to Exit Menu.
- Configured date and time formats are carried throughout menus and logs.
- Any active (with energized relay) timer system, including 10-event daily timers, feed timers, and/or dosing timers, are NOT recalculated when the 5X00 time and/or date is changed. Once a timer relay has been energized, it runs for the duration and does not reset based on changes to the 5X00 date and time. Example - timer 1, event 1 is configured to come on at 9:00am for 10 minutes. Timer relay energizes at 9:00am. At 9:05am the 5X00 time is changed to 10:05am (for daylight savings adjustment). The timer relay will de-energize after five additional minutes. The 5X00 time will be 10:10am. The event log will reflect the configured 5X00 time when the event occurred. In this example, 9:00am for the start and 10:10am for the end.
- The time must be manually changed for daylight savings time adjustments. Daylight savings note: Sensor data log records are not overwritten when the

clock is changed unless the instrument is power cycled after changing the data and time. Example - the data log interval is set to 15 minutes. Current instrument time is 6:00 am. The clock is adjusted to 5:00 am for daylight savings time. The 5X00 sensor log contains four 15 minute interval records from 5:00 am to 6:00 am from prior to time change. Sensor data logs are not overwritten with new values for the repeat of 5:00 am to 6:00 am 15 minute intervals unless the instrument is power cycled.

- Menu configurations are saved to the system by pressing Exit Menu to return to the Run Screen and not when the change is made in the menu. Exception - Date and time and clear data logs are updated immediately to the system, not when Exit Menu is pressed.

Display Settings

Menus → System → Display Settings

Sensor and Aux conditions are displayed at the Run Screen. Use the Display Settings menu to configure how many systems display on one page at the Run Screen. Up to six systems can be displayed on one Run Screen page. Multiple Run Screen pages scroll at user configured speed (1-65535 seconds).

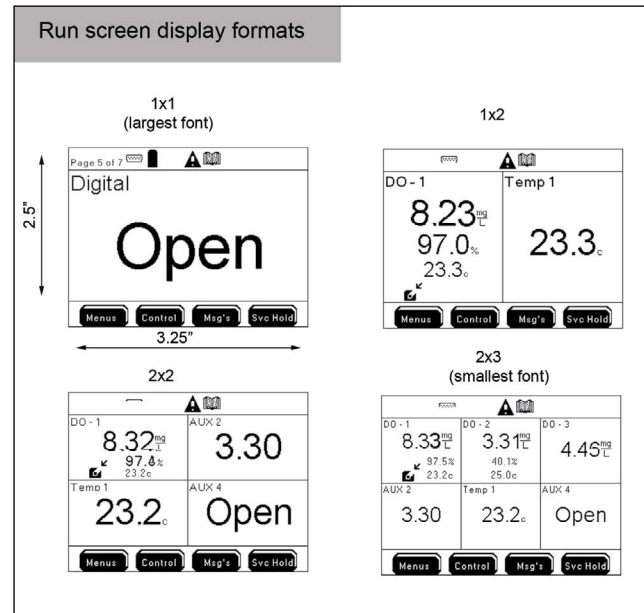

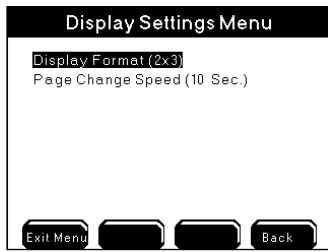

1. Enter Display Settings menu
Menus → System → Display Settings → Display Format
2. Use ▲ and ▼ to scroll and highlight submenus.
3. Press → to select.
4. to save configuration and return to Run Screen .

Notes:

- At 1x2 & 2x2 display settings, analog aux values over 7 digits will overlap on to the adjoining sensor window. Adjust aux display format to lower resolution.
- Because of font limitations, 1X2 and 2X3 display formats do not show all 20 characters of a 20 character name. Typically only 13 characters are displayed.

ODO Cal K (5500D-01, 5500D-02 and 5500D-04)

Menus → System → ODO Cal K → DO1-DO4

5500 The ODO Cal K system menu appears only in 5500D-01, 5500D-02 and 5500D-04 instruments. This menu is for viewing and uploading DO sensor cap calibration codes. Uploading ODO sensor cap calibration codes is required whenever a sensor cap is replaced.



Cap calibration codes are not stored in the 5500D instrument but rather are stored in the ODO sensor. Upon selecting DO-1, DO-2, DO3 or DO-4 at the ODO Cal K menu, communication initiates between the instrument and the sensor. An ODO sensor has six cap calibration codes. They are known as K1, K2, K3, K4, K5 and KC.

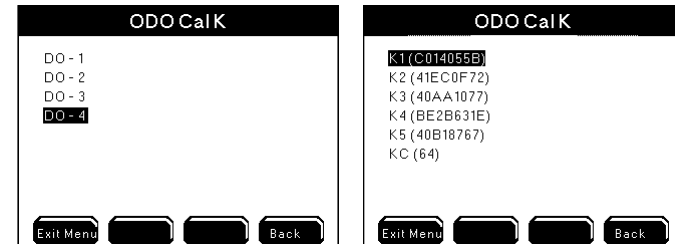

Direction to view or upload ODO sensor cap calibration codes:

1. Enter ODO Cal K menu
Menus → System → ODO Cal K → DO-1, DO-2, DO-3, DO-4
2. Select DO -1, DO-2, DO-3 or DO-4
ODO sensor cap calibration codes are displayed

If the 5500D is unable to obtain the cap calibration codes from the ODO sensor the below error message is displayed. Typically a retry after several seconds will display the ODO sensor cap calibration codes. If the calibration codes cannot be displayed confirm that the ODO sensor is displaying a value at the run screen.

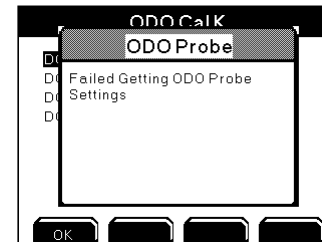

3. To upload sensor cap calibration codes select K1, K2, K3, K4, K5 or KC.
4. Use alpha/numeric keyboard to enter the values exactly as provided on the sensor cap instruction sheet sent from YSI.

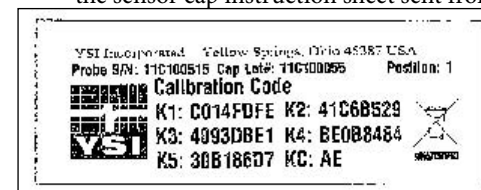

- After entering all K values press **Back**. This initiates a validation of the entered values. (Do NOT press **Exit Menu** softkey. Pressing the **Exit Menu** key results in no saving of data in the ODO Cal K values. ODO Cal K values will not be changed.)

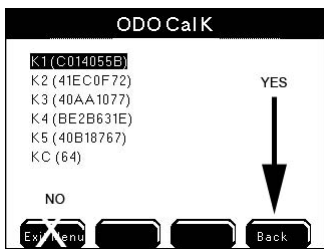

When invalid calibration code data is entered, the below message appears.

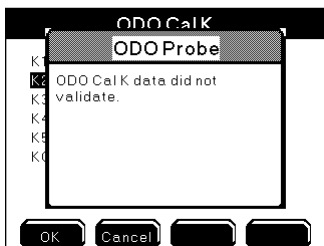

- If no validation error message is displayed, the ODO calibration codes were entered correctly. **Exit Menu** to save and return to run screen.

Notes:

- It is not necessary to load sensor cap coefficients when a new ODO probe is installed. A new cable/probe assembly has a sensor cap installed and the sensor cap coefficients are preloaded into the probe at the factory.
- If ODO calibration codes are not uploaded when the sensor cap is replaced the ODO may not operate accurately.

Downloader/Updating 5X00 Firmware

Like all microprocessor based instruments, it may be necessary to upload revisions to 5X00 firmware. Download new firmware using the Flash Programmer utility in AquaManager. A serial RS232 connection is necessary to run the Flash Programmer utility.

The instrument firmware may get corrupted if any of the following occurs during a 5X00 firmware update:

- Firmware Updater window utility is closed;
- AquaManager is closed;
- RS232 cable is removed from 5X00 or PC com port;
- power is disconnected from 5X00.

If the 5X00 firmware becomes corrupt and is not updated properly, it may be necessary to return the instrument to YSI.

Firmware Updater Directions

- Wire RS232 connection. See *RS232 Communication* - page 66. (Disregard if already using RS232 connection.)

Note:

Connect RS232 directly into slaves in order to upload firmware to slaves. Disable slaves at the master to avoid slave failure alarms when uploading - **Menus → System → Communications → Network → Master.**

- Enable the Force Serial Port on 5X00s wired and configured with an ethernet device - page 101.
- Verify that the baud rate in 5X00 Communications menu is configured to 115200.
- From the AquaManager Explorer window, access the Flash Programmer utility from the pull down menu: **Tools → Instrument tools → Update Firmware.**

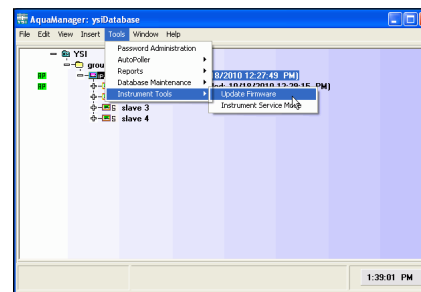

- Configure PC com port number (1-8) in Flash Programmer.

Notes:

- Use only a Tripp-Lite Keyspan USB-Serial Adapter, model USA-19HS YSI p/n 773.

- When using USB-Serial Adapter, verify that the port number assigned during driver installation is the same port configured when using AquaManager Flash Programmer.

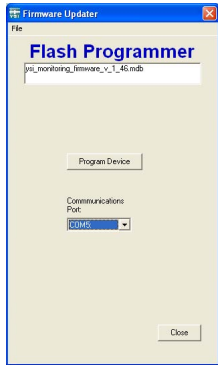

6. AquaManager Program Folder includes the latest version of instrument firmware. The latest firmware is stored as an .mdb file in the PC Program Files>AquaManager>Firmware. At AquaManager, Firmware Updater>File>Load Firmware Database. Locate and load this file into the Firmware Updater.

7. Left click **Program Device** button.

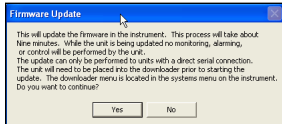

window opens.

8. Select “Yes” and the following screens will appear.

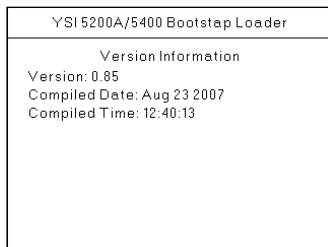

On instrument
YSI 5200A/5400/5500 Bootstrap Loader screen

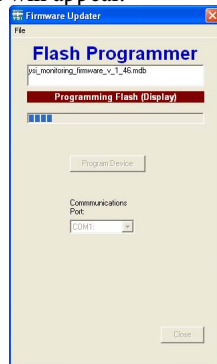

On PC
Flash Programmer uploading firmware into 5X00

Note:

- If the YSI 5200A/5400 Bootstrap Loader screen does not appear at the instrument after above steps manually place 5X00 in downloader at **Menu** → **System** → **Downloader**. Close and reopen AquaManager. Reopen Flash Programmer and repeat steps starting at 6.
- **Power cycle to exit downloader and return to run screen. Do not power cycle during an active upload.**

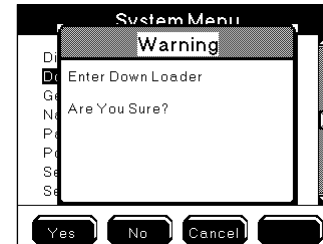

- If after manually placing the 5X00 into downloader and the Flash Programmer utility still does not upload firmware see Force Downloader - page 130.
9. The 5X00 will reboot (power cycle) when firmware upload is complete.



10. Select “ok” when this window appears
11. Close Flash Programmer.
12. Verify version information to confirm downloaded code:
Menu → **System** → **Version**
13. If applicable, disable Force Serial Port configuration.

Notes:

- During upload, 5X00 systems are placed into Service Hold which de-energizes any active systems including energized relays. See *SVR Hold Menu* - page 147 for additional information. No “off” event is created for system relays that de-energize when 5X00 is placed in downloader. Systems are reset when power is cycled after downloader.
- All logs and unit configuration are retained when 5X00 firmware is updated.
- Display board code loads first, followed by control board code. The display board screen flickers when display board code is loading. The display stops flickering when the control board code is loading. The Firmware Updater progress bar will complete two full scrolls during firmware updating.
- Total download time is approximately nine minutes; eight minutes to upload display board firmware and about one minute to upload control board firmware.
- Autopoll must be shut down when firmware is uploaded to 5X00.

Flash Programmer Updater Messages

The Firmware Updater program may respond with one of the following messages to indicate that the upload did not occur.

“Timed out” or “Could not find Unit” messages indicate a communication problem between PC and 5X00. Reconfirm Communication menu configuration, com port settings, and RS232 connections. (A power cycle may be required to access the Communications menu.)

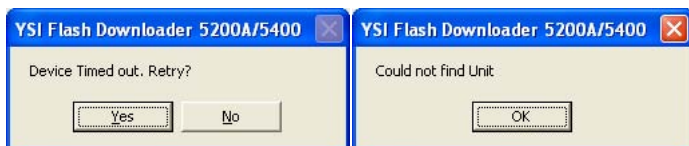

“Unit is Up-To-Date” indicates that the 5X00 has most recent firmware and upload is not necessary.



Force Downloader

If above steps result in errors and if the upload is still unsuccessful, it is possible that the 5X00 is not in downloader mode. Force the 5X00 into downloader following the steps below.

A status LED on the I/O Board must be visible to determine if the 5X00 is in downloader mode. The status LED flashes about 10 times in 5 seconds when in downloader mode. When not in downloader mode, the status LED flashes more quickly about 15 flashes in 5 seconds. The led at the “status/reset” location of the I/O Board indicates the current status of 5X00 boards.

Directions to Force 5X00 into Downloader

1. **WARNING:** Disconnect external power to 5X00. (AVERTISSEMENT : déconnectez l'alimentation externe de l'unité.)
2. Open front panel - page 41.

3. Depress reset button on I/O board (see figure below) and hold down the enter key on the front panel. Use a paper clip or other sturdy piece of wire to access the reset button through the I/O metal plate. Ensure that you are only touching the reset button on the I/O board and the enter key, then turn power on. The Downloader (bootstrap loader) screen should appear on the instrument.

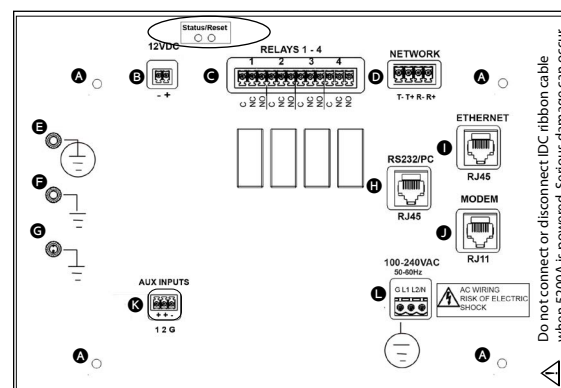

4. Proceed with uploading firmware with Flash Programmer Updater utility. Repeat steps starting at 8 of Firmware Updater directions.

General Alarm

Menus → System → General Alarm

The General Alarm triggers the buzzer, general alarm relay, general alarm icon, and 5X00 emails. Sensor and aux system alarms, slave failure (networks), low battery alarms and ODO probe failure (ODO probe failure alarms apply to only 5500D-01, 5500D-02 and 5500D-04 instruments) alarms trigger the General Alarm when enabled. **If individual system alarms are not enabled, the General Alarm will not trigger.**

The General Alarm (buzzer, relay, emails, icon) remains active until one of the four softkeys **Menus**, **Control**, **Msg's**, **Svc Hold**, on the front panel is pressed. Pressing one of the four softkeys while in the Run Screen stops the buzzer, de-energizes the General Alarm relay, stops 5X00 emails, and removes the General Alarm icon. Pressing one of these keys also resets the sensor and aux alarm systems. If the alarm condition still exists after Alarm Hold period(s), the General Alarm triggers again. Low battery and slave failure alarms are not reset when softkeys are pressed.

Sensor alarm values set the acceptable control range. When a sensor reports a value \leq low alarm value or \geq high alarm value, the alarm system becomes active after the alarm hold off period. See Sensor Setup section, Controls and Alarms - 152 for additional information. If an alarm system is active and alarm relay is enabled, the alarm relay energizes.

Notes:

- **The Run Screen must be displayed during normal operation. All alarm functions (5X00 email alarms, energizing of enabled alarm relays, alarm icons, and buzzer) are suspended in 5X00 menus. Alarm systems are reset when menus are exited to Run Screen.**
- The General Alarm system is disabled during system-wide events such as service hold and downloader.
- Sensor and Aux alarms must be enabled to trigger the General Alarm.

Alarm Hold Off

Menus → System → General Alarm → Alarm Hold Off→Time Units

General Alarm Hold Off is the length of time the alarm condition must exist before the General Alarm system becomes active.

Notes:

- To avoid alarms for spurious events set the Alarm Hold Off > than 0.
- Aux system alarms are triggered after the Aux hold off time, and not after the General Alarm hold off time.
- Low battery alarm has a five (5) second hold off that is not user selectable.

Relay

Menus → System → General Alarm → Relay

NEW The General Alarm relay can be wired and configured to *any* networked output relay. The configured relay energizes when the General Alarm system is active. See page 86 for explanation of local versus remote instruments.

Configure General Alarm relay

Use AquaManager to configure system inputs and outputs - page “Use AquaManager to configure Sensor Setup menus” on page 150.

1. Wire relay output device to local instrument, or any networked 5X00 instrument - page 54.
- OR
1. Wire relay output device to REM - see IOEM/REM Safety and Installation guide>Chapter 3>Step 4>Wire REM Relay Outputs.

2. Enter General Alarm Menu

Menus → System → General Alarm>General Alarm Menu opens



3. Use ▲ ▼ to scroll and highlight submenus.
 4. Press ↵ to select.
 5. Enable and configure Alarm Hold Off and Alarm Hold Off time and time units. Use AquaManager to configure system inputs and outputs - page 148.
- OR
5. Enter General Alarm Relay Menu>General Alarm Relay menu opens
 - A. Select Instrument to enter device address menu and configure instrument whose relay will be used for this instrument’s general alarm output.

Notes:

- Device Address menu displays a generic list of instruments being Local Machine, Master and Slaves 1-31.
- Device Address menu always display slaves 1-31 regardless of the actual number of slaves wired to the node network

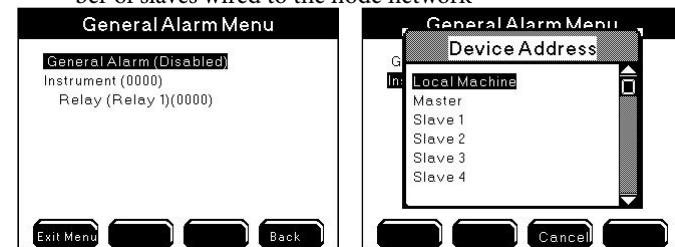

- B. Select Relay to enter Relay menu and configure instrument relay channel that will be used for this instrument’s general alarm output.

Note:

- When Device Address is anything other than Local Machine all relay assignment menus remain generic. This means that regardless of the type of remote instrument being configured Relays 1- 8 are displayed. This is true for slave 5200A and REM remote devices which only have 4 relays.



6. Press  to save configuration and return to Run Screen.
7. Test General Alarm Relay output at →System→Service→Output Test - page 144 or create a general alarm event to verify configured general alarm relay energizes.

Note:

- The General Alarm does not create an event log or control message regardless if a General Alarm relay is enabled.

Name Devices/Sensors





Menus → System → Name Devices/Sensors

Names can be user configured for 5X00 instrument, sensor aux and E-Aux systems, and relays. Default names are displayed at the local instrument when names are not user configured. 5X00 default system names are: DO1-4 (depending on 5X00 model number), Aux 1-6, E-Aux 1-8 and Relay 1-8. Default names for Aux 3-6 configured as temperature systems are Temp 1-4. Instrument and Relay names are displayed at many local instrument's menus. System names are displayed at Run Screen, sensor setup configuration, and control messages menus and screens. Because networked instruments can use relays from remote networked instruments, it is important to know that configured instrument and relay names are displayed differently at local versus remote instruments' relay menus. See additional information starting on page 136.

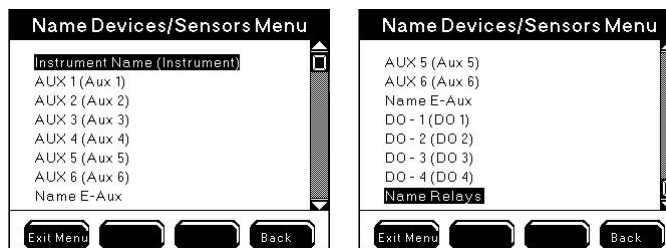
Configure device and sensor names

1. Enter Name Devices/Sensors menu
 Menus → System → Name Devices/Sensors>Name Devices/
 Sensors Menu opens



2. Use   to scroll and highlight submenus.
3. Press  to select.
4. Use keypad  to configure name.
5. Press  to save configuration and return to Run Screen.

Notes:

- See information regarding instrument and relay name conventions across a node network - page 136.
- Names can contain up to 20 characters.
- Use AquaManager to easily configure names using the PC keyboard. See AquaManager help.
- Names uploaded in the temperature system name field within the temperature system tab are displayed at the run screen, configuration menus, and control messages menus.
- Instrument, Aux & Sensor Names are not cleared at Reset to factory menus.
- Relays names are cleared at “reset relays”, “reset all systems” and “reset to factory/reset all” service menus.
- 5X00 default system name is displayed at event, sensor, and calibration logs, regardless if system name is user configured.
- At alpha/numeric keypad enter character then press “Clear” at keypad and then press  to clear user configured names.
- Aux and E-Aux system names can also be configured at: Menus → System → Configure Aux /Configure E-Aux→Aux 1-6/Eaux 1-8→Name
- Because of font limitations, 1X2 and 2X3 display formats do not show all 20 characters of a 20 character name. Typically only 13 characters are displayed.
- The instrument name is not shown at Run Screen. The instrument name is shown at relay enable menus for a local instrument only.
- Certain menus (i.e. configure aux) display up to 18 characters of the device name. “...” is shown at the menu if the name exceeds 18 characters.

Below are screen shots of Run Screen and system low alarm menu displaying user configured system name CATFISH NE.

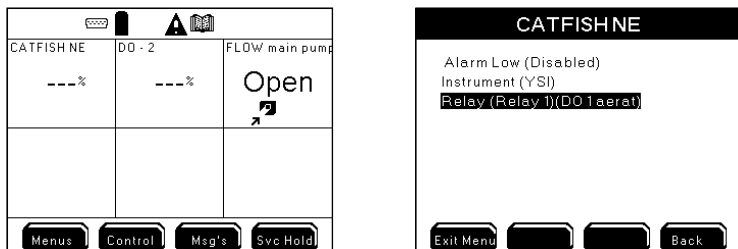

Instrument and relay name conventions across a network.

See page “Local vs Remote Instruments” on page 86 for definition of local versus remote instruments. Configured instrument and relay names are displayed differently when local versus remote instruments are selected at relay menus. An instrument is selected at the sensor>control/alarm system>Instrument window. The instrument window displays a generic list of instruments being Local Machine, Master, Slaves 1-31. Only the Local Machine user configured name is displayed. A relay is selected at the sensor or system>relay menu. The relay window displays a generic list of relays 1-8 regardless if a remote 5200A or REM instrument is selected which instruments have only 4 relays.

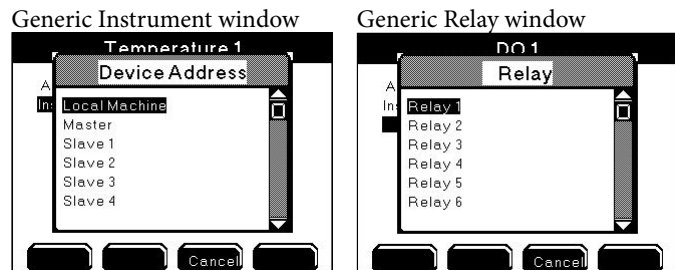

Notes:

- User configured instrument, system and relay names are displayed throughout AquaManager systems management tab. User configured names are also displayed at mapping.
- Local instrument and relay names - Sensor instrument menu displays configured (or default) local instrument name at instrument field when a prior relay assignment has not been made.

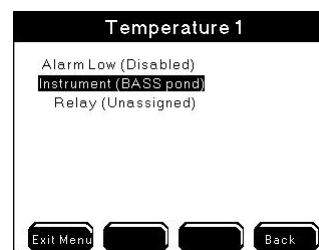

- Sensor relay menu displays configured local relay name at relay field once a local relay has been configured at the menu being viewed.

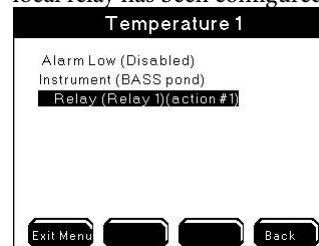

- Remote instrument and relay names - When Device Address is anything other than Local Machine all relay assignment menus remain generic. This means, Master and Slave instruments do not display their configured names, but rather the generic names of “Master” and “Slave 1-31.”

Password

Menus → System → Password

Enable and set the password in the password menu. Once the password is enabled and saved, 5X00 system menus are not accessible without first entering the correct password at the Run Screen. The password can contain up to 12 characters.



request for password to enter menus



password menu

1. Enter Password menu
 Menu → System → Password
2. Use ▲ and ▼ to scroll and highlight submenus.
3. Press ↵ to select.
4. Enable and configure submenus.
5. Press Exit Menu to save configuration and return to Run Screen.

Notes:

- Svc Hold is not password protected.
-  displays at Run Screen when password is enabled.

Power Fail Menu

Menu → System → Power Fail

In the event of AC power failure, an AC version instrument's power switches to DC if properly wired. The switch from AC to DC power is automatic and does not require 5X00 configuration. Enable *Power Fail AC Monitor* to generate an event when AC power fails and is restored. **Because AC powered 5X00s may not reboot properly after an AC power failure or AC power surge, it is highly recommended to use a battery back system when 5X00 is powered primarily by AC power.** See page 216 for DC battery maintenance information.

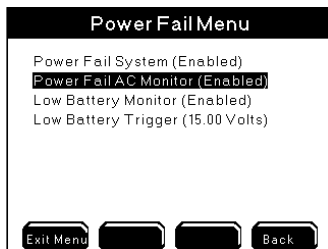

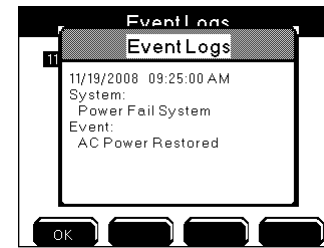

Disabling the *Power Fail System* will disable AC power events and disable the General Alarm in the event of low battery for DC power. **Disable Power Fail AC Monitor when powering 5X00 by a DC power source.**

Enable *Low Battery Monitor* to trigger General Alarm in the event DC voltage is ≤ to low battery trigger. The Low Battery Alarm Hold Off time is five (5) seconds and cannot be user configured. Once the low battery general alarm has been acknowledged by pressing one of the 4 softkeys, it is not reset. See *General Alarm* - page 131.



1. Verify AC and DC power supplies are properly wired and powered. See wire power - page 45.
2. Enter Power Fail Alarm menu and submenu
 Menu → System → Power Fail
3. Use ▲ ▼ to scroll and highlight submenus.
4. Press ↵ to select.
5. Enable and configure submenu
6. Press Exit Menu to save configuration and return to Run Screen.

Notes:

- Press Msg's to view AC power fail events.
-  icon at Run Screen indicates that the 5X00 DC power is ≥ Low Battery Trigger value with Low Battery Monitor enabled.
-  icon at Run Screen indicates DC voltage ≤ the Low Battery Trigger when Low Battery Monitor is enabled.
- Low battery alarm is not reset when front panel softkey is pressed.
- AC power fail does not generate a general alarm.

Serial Number

Menu → System → Serial Number

The serial number is displayed at the serial number menu. The serial number is required when contacting YSI customer service. The serial number is also necessary to configure AquaManager. 5400 instruments' serial numbers begin with "54-" followed by seven digits. 5500D-01, 5500D-02 and 5500D-04 instruments' serial numbers begin with "55-" followed by seven digits. Serial numbers are generated at the factory and cannot be changed by the user.

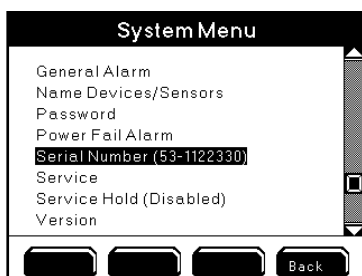

Service

Menus → System → Service

The Service menu includes submenus to configure and Reset Clean Probe timer, Reset Systems to factory defaults, and test outputs including relays and IOEM 4/20mA outputs.





Reset Clean Probes

Menus → System → Service → Reset Clean Probes

Enable clean probe timer, configure the duration, and reset clean probe days remaining from Reset Clean Probe menu. Selecting reset at this menu resets clean probe

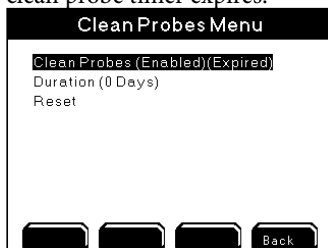
timer to the user configured value.  icon displays at Run Screen when the clean probe timer expires.



Reset Clean Probe timer at the  menu or at the Reset Clean Probes menu.



When prompted “Are you sure?”, select “Yes” to reset the clean probe timer to the user configured number of days.

Reset To Factory

Menus → System → Service → Reset To Factory

The Reset to Factory menu allows resetting of some or all of 5X00 systems to factory defaults. Example - if Clean Probe Timer is user configured to 60 days, performing a factory reset will reset the Clean Probe Timer to 90 days which is the factory default setting and not the user configured value. See *Appendix B Menu Maps* starting on page 225 for factory default settings for all systems.

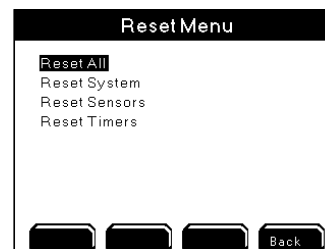



Notes:

- “Reset All” and “Reset All Systems” resets time format to 12 hour and date format to MMDDYYYY.
- It is strongly recommended that user configuration be maintained in a log by the user.
- Instrument, aux, sensor, and suffix names are not reset at any reset to factory menus. Relay names are reset at “reset relays” and “reset all” menus.
- Control icons and control menu messages are displayed for 30 seconds after pressing  from reset to factory menus for any system that was active (energized relay) prior to factory reset.

Reset All

Menus → System → Service → Reset To Factory → Reset All

Resets all systems, sensors, and timers to factory defaults.

1. Use ▲ and ▼ to scroll and highlight submenus.
2. Press ↵ to select.
3. When prompted, “Are you sure?”, select one of the following to confirm,
 
4. Press  to save configuration and return to Run Screen.

Notes:



- Display contrast, backlight timer, and buzzer can only be reset to factory defaults through this menu.
- **Sensors must be recalibrated after performing a factory Reset All and/or Reset Sensor.**

Reset System

Menus → System → Service → Reset To Factory → Reset System

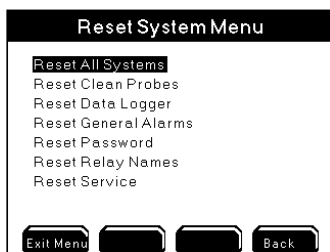
Specific systems or all systems in the Reset System menu can be reset to factory defaults.





1. Use ▲ and ▼ to scroll and highlight submenus.
2. Press ↵ to select.
3. When prompted, “Are you sure?”, select one of the following to confirm,
 
4. Press  to save configuration and return to Run Screen.

Reset Sensors

Menus → System → Service → Reset To Factory → Reset Sensors

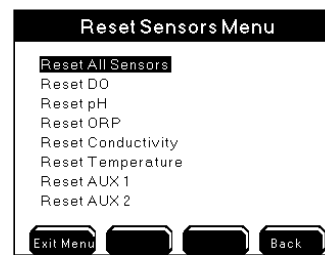
Specific sensors, aux system, or all sensor and aux systems listed in the Reset Sensors menu can be reset to factory default.

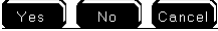

1. Use ▲ and ▼ to scroll and highlight submenus.
2. Press ↵ to select.
3. When prompted, “Are you sure?”, select one of the following to confirm,
 
4. Press  to save configuration and return to Run Screen.

Note:

- Perform a sensor calibration after resetting a sensor to factory default.





Reset Timers

Menus → System → Service → Reset To Factory → Reset Timers

A specific timer, feed timer, or all timers listed in the Reset Timers menu can be reset to factory defaults.



1. Use ▲ and ▼ to scroll and highlight submenus.

2. Press  to select.
3. When prompted, "Are you sure?", select one of the following to confirm,   
4. Press  to save configuration and return to Run Screen.

Output Test

Menus → System → Service→Output Test

Use the Output Test menu to verify that local relays and remote device relays and IOEM 4/20mA output channels, are wired and communicating correctly over the network. Entering this menu turns off any active relays and disables any sensor, aux, and timer system relays from energizing regardless of value or condition. Systems are not reset when the Output Test menu is exited. To reset systems after exiting the Relay Test menu power cycle the 5X00 whose output channel was tested. See note below.

Note:

- Timer and control icon(s) remain at the Run Screen until the system is reset. Example - the timer icon remains at systemwide location until the end of the timer cycle that was stopped when the output test menu was entered even though the relay is not energized. To reset systems after exiting the Relay Test menu, power cycle the 5X00.

Directions to test outputs

1. Enter Output Test menu
Menus → System → Service→Output Test>Output Test information warning window is displayed

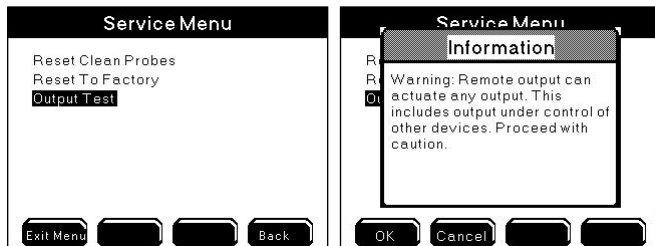

2.  at Run Screen to proceed with Output Test. Output Test Menu opens:

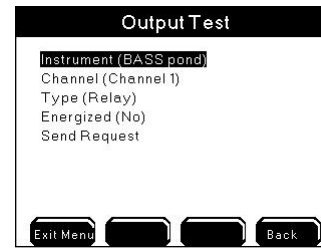

3.  at Instrument menu. Device Address menu opens. Scroll and select networked instrument whose relay or channel is to be tested.



Note:

- If local machine is selected, configured instrument name, if configured, is displayed after selection. See notes regarding local versus remote instrument and relay names in 5X00 menus - page 136.

4.  at Channel. Channel menu opens. Scroll and select channel/relay to be tested.

Notes:

- Channel names are always listed as generic channels 1-8 regardless if local machine is selected and the selected relay name has been user configured. Channel 1-8 are always listed regardless if instrument selected is a 5200A or an REM which instruments have 4 relay channels, and not 8 relay channels

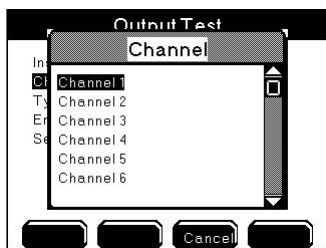

5. Scroll and select Relay or 4/20mA output type.

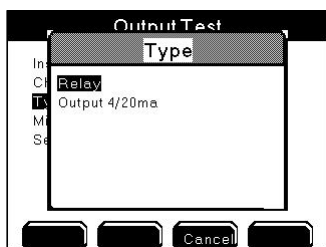

6. 4/20mA outputs test an IOEM 4/20mA output channel. For 4/20mA output test, configure a Milliamp value. The Milliamp range is 0.00 to 21.00.

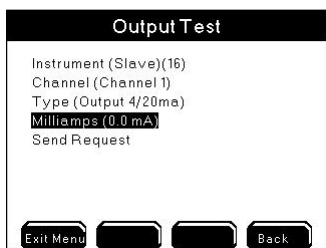

7. Select Yes at Energized menu to toggle state of output.

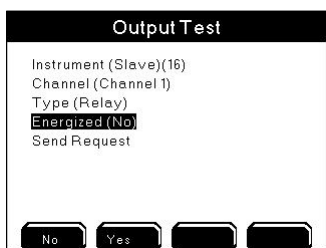

8. Scroll and select Send Request. at 5X00 Run Screen to send a command to the local, or networked, instrument to trigger configured output test condition.
9. Verify locally, at the instrument whose output is being tested, that output is at correct state or value.
10. after completing instrument channel output testing.

Service Hold

Menus → System → Service Hold

Pressing at the Run Screen puts the 5X00 into Service Hold. The Service Hold time is user selectable (1-255 sec, min, or hours). Service Hold turns off any active relays and disables any sensor, aux, and timer system relays from energizing regardless of value or condition. 5X00 alarm emails are not sent during service hold. After the service hold time expires, or is cancelled, the sensor systems are reset after 30 seconds. Timer systems are not reset.

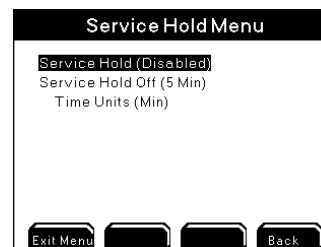

1. Use and to scroll and highlight submenus.
2. Press to select.
3. Enable and configure submenus.
4. Press to save configuration and return to Run Screen.
5. Press at Run Screen to enter Service Hold. See Svr Hold - page 196 for additional information.

Note:

- Place the 5X00 in service hold as instructed in step 3 of calibration checks in Maintenance - page 209.

Version

Menus → System → Version

The Version menu contains information about the 5X00 including: display and control board firmware code version, firmware compile date and time, control board temperature, AC and DC voltage and model number.

Notes:

- Firmware version information is required when contacting YSI support.
- The clock chip temperature range starts at 0°C. Values < 0°C are not valid numbers.
- The normal operating range temperature will be a few degrees above ambient.
- AC powered units will run at a higher temperature than DC powered units.
- To view current AC and DC power values  to return to run screen and then return to menu. Power information does not refresh when version menu is open.

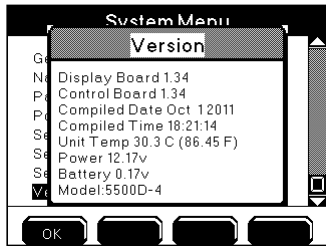

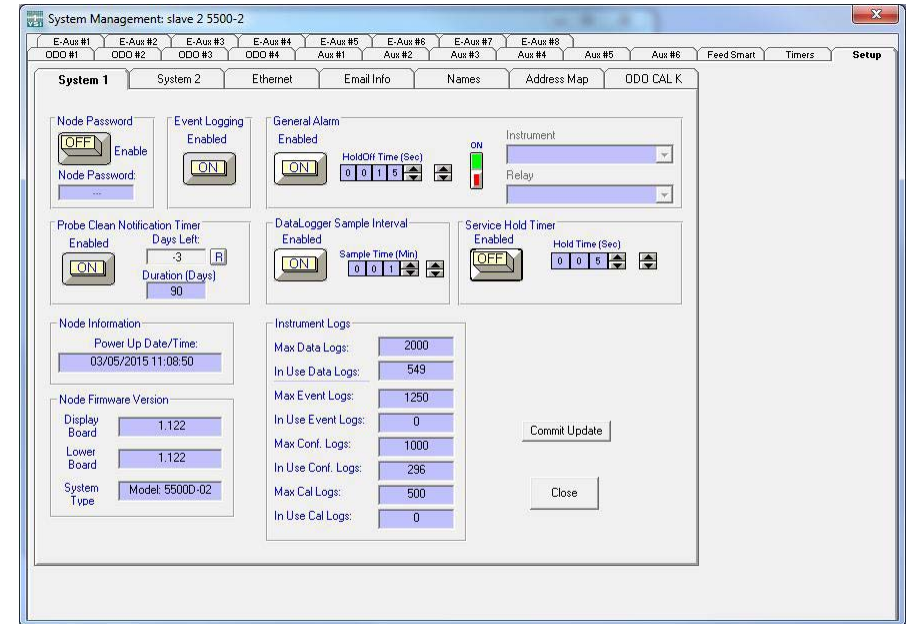

AquaManager and the System Menu

 AquaManager users can configure most 5X00 system menus from a PC. After polling the 5X00, use “Systems Management” from the node window to view and upload 5X00 configuration. System menus are configured at the Setup tab selections.



Notes:

-  Always manually poll the 5X00 after uploading configuration changes and verify uploaded information is retained. When configuration changes are uploaded using AquaManager at the same time configuration changes are being made by a user in the menus on a 5X00 instrument, the AquaManager uploads may not be saved depending on the timing of keystrokes at the 5X00.
-  **The Run Screen must be displayed during normal operation.** If the 5X00 is not at the run screen during AquaManager uploading, pressing  at the 5X00 will only save certain configuration changes.

See *Chapter 5 AquaManager* - page 197 and *AquaManager online help* for additional information.

Sensor Setup

- Menus → Sensor Setup → Aux 1-6
- E-Aux 1-8
- DO 1-4

Use AquaManager to configure System inputs and outputs

NEW Any networked 5X00 and REM instrument relay can be configured to any networked 5X00 sensor control or alarm system. In addition, any E-Aux system (see page 108) can be configured to use any networked IOEM input channel as its input source. See local versus remote instruments on a network - page 86. Because of differences in how system relay outputs and E-Aux system inputs are configured locally at a 5X00 instrument versus using AquaManager, **it is strongly recommended that AquaManager be used to configure all 5X00 sensor setup menus. AquaManager contains a number of software checks that help to validate E-Aux input and 5X00 system output relay assignment configuration. These same checks do not exist when configuring systems directly at a 5X00 instrument.** AquaManager maintains an up to date table of all node network instruments. This table gives AquaManager the ability to display only networked instruments at E-Aux source input and system relay output pulldown menus. (This AquaManager table is not visible to the user.)

An Example of configuring a 5X00 system control relay at an instrument versus using AquaManager is provided below. The node network used in the example includes a master (being a 5500D-04) and 4 slaves (slave 2 being a 5500D-02; slave 4 being a 5400; slave 11 being a 5200A; slave 16 being an REM).

Instrument configuration - the control relay instrument menus displays a generic list of instruments. See instrument and relay name conventions - page 136. Any instrument from the generic list can be selected/configured. This generic list in no way accurately depicts the instruments on the actual node network. In this example, the node network consists of a master and slave 2, slave 4 and slave 11 and slave 16, yet at the system control instrument menu a generic list of instruments is displayed. Which generic list includes Local Machine, Master and Slaves 1-31 and not just the 4 instruments on the node network. The relay list also displays a generic list which displays relays 1-8 for all instruments. This generic list list does not take into account that 5200As and REMs have 4 relays and not 8 relays. instruments. See screen shots below of instrument and relay menus at instrument.

Control system instrument menu

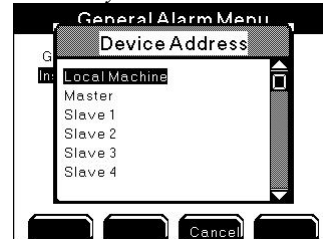

Control system relay menu

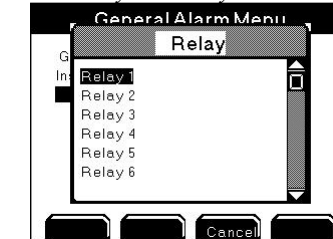

AquaManager configuration - in the alternative, AquaManager knows what instruments are actually on the node network and consequently knows actual relays available on each instrument. In this example, only the Master 5500D-04 and slaves on the network are available at the instrument menu pull down. Each instrument also will display only available relays based on the instrument type. In the relay menu screen shot below 4 relays are displayed because Slave 16, an REM, was selected. See screen shots below for AquaManager pull downs.

Control system instrument menu

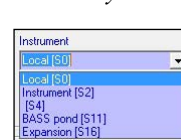

Control system relay menu



Sensor Setup

Aux , E-Aux and DO set points (setpoint, control and alarm), control mode (set point, PID/PWM, or PID/4/20mA) and sensor system relays are configured in Sensor Setup menus. All networked instrument relays can be configured for control and alarm output devices - see Use AquaManager to configure System inputs and outputs - page 150. Properly wired and configured relays energize when a control or alarm system is active. Alarm notifications can be sent via email or cell phone (SMS messaging) - page 90.

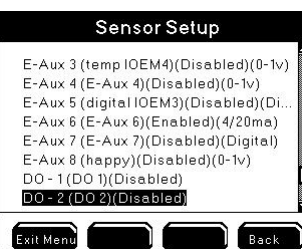
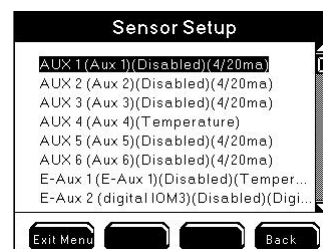

Notes:

- **For normal operation, the 5X00 must be at the Run Screen. Alarm functionality (email alarms, activation of assigned alarm relays, alarm icons, and buzzer) is suspended when 5X00 is not at Run Screen.**
- **Sensor system must be enabled in order to display values at Run Screen. Control and/or alarm relays will not energize regardless of value if the sensor system is disabled.**
- There is a 30 second delay at power up before control, timer, and alarm systems become active.
- There is a 30 second sensor system hold off when sensor configuration is changed. See *30 Second Sensor System Hold Off* - page 163.
- Calibrate sensor prior to use. See *Calibration* - page 82.
- “Over” and “Under” readings are displayed when DO sensor is measuring outside it’s operating range - see *DO range specification* - page 14 DO control and alarm functions including relays are suspended when a sensor is reading “Over” or “Under.”
- “Over” and “Under” are not displayed for aux temperature systems when temperature values are outside the temperature operating range - see *Temperature Range Specification* - page 15. Temperature system controls and alarms will not operate correctly when values are outside the temperature operating range.
- DO “Over” and “Under” readings most likely indicate that the sensor needs to be serviced or replaced, or a bad probe or cable connection exists.
- One relay can be assigned to multiple systems. It is essential that the relay configuration be verified in order to avoid conflict of operation of wired relay devices. Assigning one relay to multiple systems can result in invalid operation.

Control Mode

Menus → Sensor Setup → Aux 1-6 → Control Mode
 → E-Aux 1-8 → Control Mode
 → DO 1-4 → Control Mode

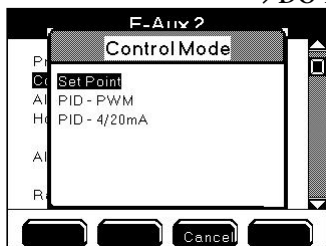

Configure DO, Aux and E-Aux non digital systems to control and alarm at user configured values to best manage your aquatic system. Sensors and aux and E-Aux analog devices report values to the 5X00. Wire and configure peripheral devices

(outputs) to turn on and off in order to maintain certain water conditions as close to the setpoint as possible. 5X00 instruments have three control modes. They are Set Point control which is described starting on this page, PID/PWM and PID 4/20mA control which are described starting on page 159. Control mode configuration determines how a 5X00 instrument maintains a water parameter as close to setpoint as possible. System menu options change based on the control mode.

Follow page links below to see examples of instrument menus displayed for different control mode:

- E-Aux 4/20mA system Set point control example - page 167;
- Aux and E-Aux digital - page 164. (Digital inputs do not have a control mode selection.);
- Temperature Set point control mode example - page 168;
- DO Set point control mode example - page 173;
- PID/PWM and PID 4/20mA control mode example - page 176;

Notes:

- Aux and E-Aux digital systems do not use control modes. See page 165 for complete aux and E-Aux digital configuration information.
- Sensor Setup menu selections change based on the configured control mode.
- Changing control modes may result in invalid set point, control and alarm value configurations. Always reconfirm control and alarm menu configuration when control mode is changed.

Set Point Control

When a system is operating in Set point control mode control and alarm relays energize when user configured values are reported to the 5X00 from the input sensor or device. A control relay remains energized until the the system set point value is processed by the 5X00.* Configure sensor control relays using AquaManager - see page “Use AquaManager to configure system inputs and outputs” on page 150. See Set Point Alarm Values - page 156 for alarm relay functionality.

*exception - high temperature, and high and low analog aux and E-Aux systems may also be configured for a timed set point mode - see page 157.

Follow page links below to see examples of instrument menus displayed for set point control mode:

- E-Aux 4/20mA system Set point control example - page 167;
- Temperature Set point control mode example - page 168;
- DO Set point control mode example - page 173;

Below are screen shots of an E-Aux temperature system menu configured in Set Point control mode.

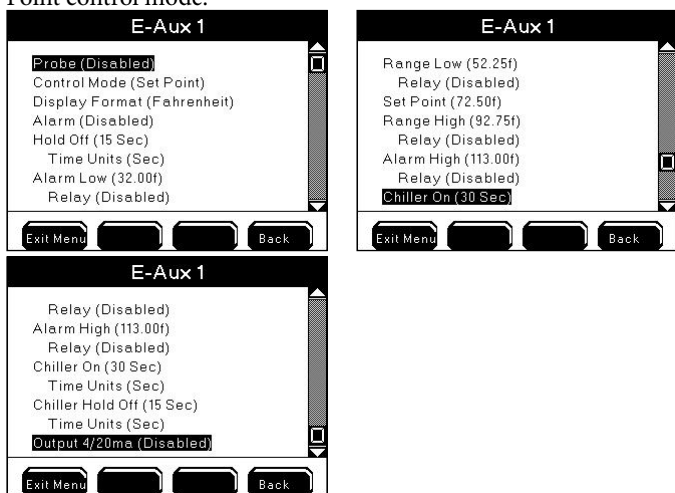

Control relays configured in the Set Point control mode energize when a user configured control value is received from the input device and is processed by the 5X00. Control relays can be configured to raise and/or lower DO and non digital aux and E-Aux systems. Configure high and/or low alarm systems to activate peripheral devices and/or to provide alarm notification messages when alarm condition(s) exist. Configure values outside of acceptable operating control range as high and low alarm values.

Set Point Control Values

Range low and Range high values set the acceptable operating range for the water system. Control system(s) do not become active when value(s) are within acceptable control range. See figure 4.8 - page 155. Enabled control relays energize when the sensor reports a value \leq the range low control value or \geq range high control value. Control relays are typically wired to devices used to raise or lower certain water parameters in order to maintain the system as close to set point as possible. Control relays remain energized until the sensor reports a value \leq set point (when dosing down to lower specific water parameter) and/or \geq set point (when dosing up to raise specific water parameter). Exception - timed control is available for high temperature and high and low analog aux and E-Aux systems - see page 157. In timed set point control mode control relays are controlled by timers as opposed to water system value. Sensor low control range starts at -1 significant digit below set point value. High control range starts at +1 significant digit above set point value.

Figure 4.8 shows how the 5X00 operates based on a set point control sensor setup configuration. In the example provided DO range low and range low 2 devices will energize at ≤ 5.0 and ≤ 4.0 respectively. The alarm low system becomes active at ≤ 3.5 .

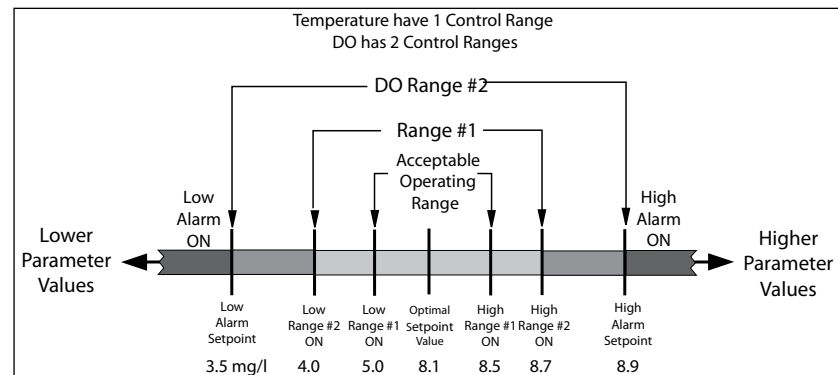



Figure 4.8

Notes:

- Configure sensor control relays using AquaManager - see page 150.
- Changing control mode may result in invalid set point, control and alarm value configurations. Always reconfirm sensor setup system menu configuration when control mode is changed.
- DO systems have two control ranges. They are referred to as Range Low & Range Low 2 and Range High & Range High 2.
- Control systems remain active when the user is in 5X00 menus.
- Control icons display at the Run Screen when relays are energized - see *Icons* - page 76.
- Press  at Run Screen to display active sensor and aux system relays.
- Press  at Run Screen to display events created by control and alarm relays - see *Event Log* - page 120.
- Control relays are not energized if the 5X00 DO sensor value reads "Over" or "Under."
- "Over" and "Under" are not displayed for aux temperature systems when temperature values are outside the temperature operating range - see *temperature range specification* - page 15. Temperature system controls will not operate correctly when values are outside the temperature operating range.
- See *Wire Relays* - page 54 for information on wiring control output devices on a 5X00 instrument. See *IOEM/REM Safety and Installation guide*>Chapter 3>Step 4>Wire REM Relay Outputs.

Set Point Alarm Values

Alarm values set the acceptable control range. Alarm system(s) do not become active when values are within acceptable control range. See figure 4.8 - page 155. Enable and configure system alarm(s) to activate alarm output device(s), view alarm icons, hear audible alarm and/or receive alarm notifications sent via email or cell phone (SMS) - page 90. Configure high and low alarm values to set alarm thresholds. Alarm system(s) becomes active when value is \leq low alarm value or \geq high alarm value. Enabled alarm relays energize if alarm condition exists for the general alarm hold off time. Alarm relays are energized until one of the four softkeys **Menu**, **Control**, **Msg's**, **Svc Hold** is pressed regardless of sensor value. Pressing one of four softkeys resets the alarm system. Alarm systems become active again if, after the alarm hold off period, the alarm condition still exists. Alarm hold off is configured in the General Alarm menu.

When the General Alarm is enabled, (with or without enabled relay), the general alarm system becomes active when any system alarm is active. See *General Alarm* - page 131.

System low alarm range starts at -1 significant digit below low control value. High alarm range starts at +1 significant digit above high control value.

Notes:

- Configure sensor alarm relays using AquaManager - see page 150.
- **It is important to keep the 5X00 at the Run Screen during normal operation. Alarm functionality (email alarms, activation of enabled alarm relays, alarm icons, and buzzer) is suspended when 5X00 is not at Run Screen.**
- Alarm icon(s) display at the Run Screen when alarm condition(s) exists for longer than the general alarm hold off time. See *Icons* - page 76.
- Press **Control** at Run Screen to display active sensor and aux system relays.
- **Msg's** to display events created by control and alarm relays - see *Event Log* - page 120.
- Alarm relays are not energized if the 5X00 DO sensor value reads "Over" or "Under."
- "Over" and "Under" are not displayed for aux temperature systems when temperature values are outside the temperature range specification - see *temperature range specification* - page 15. Temperature system alarms will not operate correctly when values are outside the temperature range specification.
- See *Wire Relays* - page 54 for information on wiring control output devices on a 5X00 instrument. See IOEM/REM Safety and Installation guide>Chapter 3>Step 4>Wire REM Relay Outputs.

Timed versus Normal (non timed) Control

Timed control is available for high temperature and high and low analog aux and E-Aux systems. In timed set point control mode control relays are controlled by timers as opposed to water system value. All systems can be controlled in a non timed (normal) control mode by configuring dose on/chiller on time to 0. This will cause the system's control relays to remain energized until the set point value is reached.

In a set point timed mode, a control relay energizes for the dose on time regardless if the sensor reports that a value has returned to the set point value. The control relay deenergizes at the end of the dose time and then waits a user configured "wait", "dwell", or "hold off" time before resampling. If, after the wait time, the system is still in control range the control relay will energize again for the dose on time.

In the case of a temperature high set point time control mode it is recommended to configure the chiller hold off time to a value of eight (8) minutes, or more. This amount of time will help to avoid chiller compressor damage due to many on/off's.

Notes:

- A chiller off time must be configured in the timed mode or the control relay will never de-energize.
- Since most heaters and chillers have their own thermostats, their thermostats can be used as a backup temperature control system. Set the heater thermostat control several degrees above the desired temperature and the chiller thermostat control several degrees below the desired temperature.
- Active sensor control timers are reset after systemwide events. Systemwide events de-energize relays. Example - chiller on time is configured for an eight (8) minute on time. Energized chiller (control down) relay de-energizes when 5X00 goes into Svr Hold. The chiller on relay had been energized for three (3) minutes before the Svr Hold occurred. The Svr Hold time is one (1) minute. If the sensor is reporting control low condition after the service hold time period, the chiller on time will be for eight (8) minutes and not the remaining five (5) minutes of the chiller on time prior to entering Svr Hold.
- Control down relay (chiller) energizes for original "on time" if chiller "on time" is reconfigured when relay is energized.

Validation Error and Autofix - Set Point Control Only

When an invalid value is entered at the numeric keypad a Validation Error window displays. An invalid value is either a value outside the range of the sensor system or a value that breaches other settings within the sensor system. Autofix occurs when a high or low control value is entered that breaches the set point value. Examples are provided below:

Low range control value must be < set point value. High range control value must be > set point value. Low alarm value must be < low control value. High alarm value must be > high control value.

Example - entering “63” for DO set point results in validation error because the valid range for the DO sensor system is 0.00 to 60.0 mg/l. User must configure value within valid range. In addition, the value cannot breach respective control and alarm system values.

Example - configuring set point value of 8.00 mg/L with range low value of 8.00 mg/l results in validation error. Valid set point range is displayed at validation error display. Press **OK** to return to numeric keypad to enter valid value.

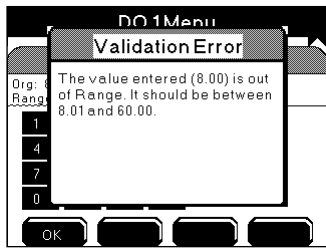

Autofix occurs when a high or low control value is entered that breaches the set point value. Autofix changes the high or low control value by one least significant digit away from the set point value. The set point value is never adjusted.

Example - Entering 8.00 mg/L as the range low value when the set point value is 8.00 mg/L results in an auto fix of the control value. The invalid control value is displayed at the sensor setup menu. Pressing **Exit Menu** is not an option after saving a value at numeric keypad. Press **Back** from the sensor setup menu to continue with the autofix. A validation error window is displayed to show that the autofix has occurred. Press **OK** to return to sensor setup menu. Verify that the autofixed values are configured for user’s specific application and reconfigure as needed. Press **Exit Menu** to save configuration and return to Run Screen.

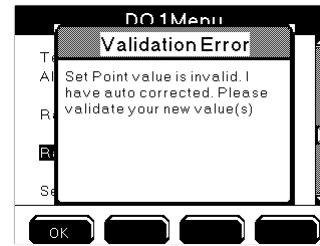

PID/PWM and PID 4/20mA Control mode

Configure PID/PDW and PID 4/20mA control mode at Sensor Setup menus. (PID /PWM and PID 4/20mA control modes are also referred to as PID control modes). PID stands for Proportional, Integral and Derivative. PWM stands for pulse-width modulation. PID/PWM and PID 4/20mA control modes operate similarly but use different output to control the control outcome. The difference is that a system configured in PID/PWM control mode uses a relay as the output control device and a PID 4/20mA control mode system, instead, drives a 4/20mA output device, such a valve, to control the system. Both control modes use a complex algorithm in determining the best way to sustain water system value(s) around a set point using a relay PID/PWM (on/off) or a value PID 4/20mA. Both control modes can be used to control an output device to maintain a certain water parameter at its set point. Both PID 4/20mA and PID/PWM control modes are feed back control systems. Three factors determine how these control modes seek to maintain water system value(s) around a set point. The three factors are:

- the error (distance) from present measurement of input to set point (present time);
- the duration of the error (accumulation of past errors);
- the speed at which the value is approaching the set point (predicts future errors);

PID/PWM and PID 4/20mA control systems are considered active whenever error exists away from the configured set point. PID/PWM and PI 4/20mA control systems are flexible and can be tuned to keep water systems around their set points even though the environment is exposed to disturbances that drive the input value away from set point. An example of a PID control system that most readers will be familiar with is a cruise control system in a car. Acceleration and deceleration adjustments are continually being made to maintain the car at a constant speed or set point.

PID/PWM and PID 4/20mA control mode allows configuration of high and low alarm systems which alarm systems activate peripheral devices and/or provide alarm notification messages when alarm condition(s) exist.

Follow page link below to see example to configure PID control mode:

-PID/PWM and PID 4/20mA control mode example - page 176;

Notes:

- Changing control method between PID and Set Point may result in invalid setp point, control and alarm value configurations. Always reconfirm sensor setup system menu configuration when control mode is changed.
- PID control is not available for aux digital systems.
- DO system(s) PID set point can be configured using either mg/L or %Sat.

In contrast to the Set Point Control mode - page 153, when a system is operating in PID/PWM or PID 4/20 mA control mode there are no user configured control values. Instead control relays energize anytime a value is reported that is away from the set point and the output *on time* is proportional to certain conditions and values being reported to the 5X00.

PID/PDW and PID 4/20mA menu configurations are described in following sections.

-Interval - see page 162

-Gain - see page 162

-Reset Interval - see page 162

-Up or down control - see page 161

An example of a PID control mode system configuration is provided at page 176.

NEW PID 4/20mA Control Mode

A PID (Proportional, Integral and Derivative) 4/20mA control mode system uses an OEM 4/20mA output device to control the system. The 4/20mA output control device is wired (at an OEM instrument) - see OEM/REM Safety and Installation Guide>chapter 3>directions to wire 4/20mA outs for wiring directions and configured (using AquaManager) - see OEM/REM Safety and Installation Guide>chapter 4>configure OEM 4/20mA output for configuration directions.

PID Tuning

Each and every water system responds very differently to peripheral control devices due to many factors. Factors that can influence the ability of a control device to maintain a certain set point include size of system, peripheral equipment such as pumps, lighting, system location and the like. While PID tuning is an important and necessary requirement to properly configure the control system it is outside the scope of this document to describe the tuning process. There is a wealth of information available on the www as well as in print. Please familiarize yourself with additional information in order to further your understanding of the PID/PWM control method.



AquaManager includes a PID Tuning tool which allows simulation of various control action values and functions. The PID tuning tool should be helpful in mimicking your system through simulation. The AquaManager PID Tuning tool is explained in detail in the AquaManager Help System. At AquaManager Help Contents>Working with Nodes>PID Tuner.

Set Point

Configure the set point to be the value at which you'd like the system to ideally operate at. Configure the set point at PID mode menu. DO set point can be configured in either mg/L or %Sat at the. Configure at PID mode menu.

Control Up/Down

Configure the PID control system to either control up (Falling, to create a control action to reduce down the system water parameter value) or control down (Rising, to create a control action to increase up the system water parameter value). A PID control can be used only to control the system by either driving the system value up or down. A PID control cannot be used to drive the system value both up and down.

PID Control Actions

Interval, Gain, Reset Interval

Configuration of three control actions allows for greater control and stability of a particular environment. The control actions are Gain (page - 162), Reset/Interval (page - 162) and Interval (page -162). These three control actions are closely interrelated in terms of how the PID/PWM algorithm works. The objective is to tune and configure these control actions in order that the corrective action (output *control on time*) performed by the 5X00 results in system stability. That is, the system will hold the set point without oscillating wildly (overshooting or undershooting by significant amounts) over and under the set point. A large amount of oscillation could cause irreparable damage to the system by dosing too large an amount, or too small an amount, of a control dosing additive to the system stream.



AquaManager includes a PID Tuning tool which allows simulation of various control action values and functions. The PID tuning tool should be helpful in mimicking your system through simulation. The AquaManager PID Tuning tool is explained in detail in the AquaManager Help System.

PID Interval control action

Range 1.00 to 999 (seconds)

Configure the interval control action to be the length of time a complete PID/PDW control cycle takes. The control cycle includes both the control relay output on time and the control relay output off time. Example: A 10 second control relay on time and a 10 second control relay off time would represent a 20 second interval time. The 10 second control relay on time would be expected to decrease as the value reaches set point. Interval, Reset interval and Gain control configurations are all interrelated in the calculation of the control relay on time as the algorithm calculates the proper corrective action.

PID Reset Interval control action

Range 0.00 to 100 (seconds)

Configure the Reset control action to be the rate at which the PID/PWM cycle resets. In other words at what interval the past errors are erased and the PID/PWM process begins a new cycle using new errors, and not past errors, in the PID/PWM formula in calculating corrective action. Interval, Reset interval and Gain control configurations are all interrelated in the calculation of the control relay on time as the algorithm calculates the proper corrective action.

PID Gain control action

Range 0.01 to 10 %.

Gain is used to control the percentage of change in the output. Output increases with greater gain. A high gain results in a large change in the output for a given change in the error. A gain of “5” results in an additional 5% output relay on time for each 1% increase/decrease of the measurement. Tuning theory and industrial practice indicate that gain should contribute the bulk of the output change. Interval, Reset interval and Gain control configurations are all interrelated in the calculation of the control relay on time as the algorithm calculates the proper corrective action.

Note:

- Once a PID/PDW control relay energizes the relay completes the interval cycle based on the latest ratio error and does not automatically deenergize when the set point is reached. The PID/PWM formula resets all values to 0 once set point value is achieved and the formula is discontinued. This only occurs after the interval time expires.

PID Alarm System

Alarm values set the acceptable control range. Enable and configure system(s) alarm to activate alarm output devices(s), view alarm icons, hear audible alarm and/or receive alarm notifications sent via email or cell phone (SMS) - page 90. Configure high and low alarm values to set alarm thresholds. Alarm system(s) becomes active when value is \leq low alarm value or \geq high alarm value. Enabled alarm relays energize if alarm condition exists for the general alarm hold off time. Alarm relays are energized until one of the four softkeys **Menus**, **Control**, **Msg's**, **Svc Hold** is pressed regardless of sensor value. Pressing one of four softkeys resets the alarm system. Alarm systems become active again if, after the alarm hold off period, the alarm condition still exists. Alarm hold off is configured in the General Alarm menu.

When the General Alarm is enabled, (with or without enabled relay), the general alarm system becomes active when any system alarm is active. See *General Alarm* - page 131.

Notes:

- **It is important to keep the 5X00 at the Run Screen during normal operation. Alarm functionality (email alarms, activation of enabled alarm relays, alarm icons, and buzzer) is suspended when 5X00 is not at Run Screen.**
- Alarm icon(s) display at the Run Screen when alarm condition(s) exists for longer than the general alarm hold off time. See *Icons* - page 76.
- Press **Control** at Run Screen to display active sensor and aux system relays.
- **Msg's** to display events created by control and alarm relays - see *Event Log* - page 120.
- Alarm relays are not energized if the 5X00 DO sensor value reads “Over” or “Under.”
- “Over” and “Under” are not displayed for aux temperature systems when temperature values are outside the temperature range specification - see *temperature range specification* - page 15. Temperature system alarms will not operate correctly when values are outside the temperature range specification.
- See *Wire Relays* - page 54 for information on wiring alarm output devices.

30 Second Aux, E-Aux and Sensor System Hold Off

Exiting aux, E-Aux and sensor menus after making certain configuration changes places the system in a 30 second hold. During the 30 second sensor hold, control and alarm systems are not active. System(s) becomes active, if, after 30 seconds, the values are reported in control or alarm range. This 30 second hold off allows sensors and aux devices time to stabilize before control and/or alarm systems become active.

Example - DO sensor menu is entered and the control high set point value is changed while a control relay is energized. When **Exit Menu** is pressed to return to the Run Screen, the DO control relay de-energizes regardless of sensor value. The control relay re-energizes if, after the 30 second hold, the value is still in control range.

- Reconfiguration of the following does not place the system in 30 second hold off:
- DO systems - display format, probe type, membrane type, ppt, elevation, temp source, and temp display format;
 - Temperature system - display format, chiller on time, chiller on time units, chiller hold off time, chiller hold off time units, set points, enable/disable control relays.

- Notes:
- Configuration changes place only the system that has been reconfigured on 30 second hold.
 - No “off” event log is created when energized system relays de-energize due to 30 second sensor hold off.
 - Control icons and control messages continue to display during the 30 second sensor system hold at the Run Screen regardless if relays are energized.

Aux and E-Aux Hold Off (non temperature aux systems)

Aux and E-Aux Hold Off (user configured) is the length of time the control or alarm condition must exist before the Aux relay energizes. Aux temperature, E-Aux temperature and DO sensor systems do not have control hold off. These systems controls operate as described at set point normal control values - page 154. Aux temperature, E-Aux temperature and DO sensor alarm relays operate as described at set point normal alarm values - page 156.

- Note:
- To avoid control or alarm for spurious events, configure the Alarm Hold Off > than 0.

Aux and E-Aux Relay Digital

Menus → Sensor Setup → Aux 1-6
→ E-Aux 1-8

Configure digital control/alarm (open/closed), relay, alarms, and hold off in the Aux 1 - Aux 6 and E-Aux 1 - E-Aux 8 Sensor Setup Menu. E-Aux digital systems use an IOEM digital input as the system input. Use digital input type for control, or alarm, based on either a switch open or switch closed condition. Only one relay can be configured in a digital system. Enabled relay will energize based on the condition configured in the control/alarm on menu.

When enabled, Aux digital relay energizes when configured control/alarm on condition occurs. Aux relay energizes after configured aux hold off time. When alarms are disabled and as long as control/alarm on condition exists, the relay remains energized including when menus are entered. Relay de-energizes when the non control/alarm condition is processed by the 5X00 so long as alarms are disabled. If alarms are enabled, the relay de-energizes when one of the four front panel softkeys **Menu**, **Control**, **Msg's**, **Svc Hold** is pressed. Pressing one of four softkeys resets the alarm system. The Alarm system becomes active again if, after the aux hold off period, the alarm condition still exists.

Digital events (event log) are identified by aux/E-Aux number, input type (digital), relay condition (on/off), and do not identify digital condition (open, or closed). Aux digital events are not identified as control or alarm events regardless if alarms are enabled.

E-AUX E-Aux systems use an IOEM channel as the digital input source. See IOEM/REM Safety and Installation guide for wiring and input channel configuration.

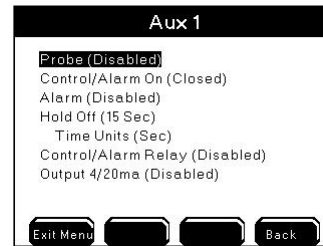

Configure Aux and E-Aux digital systems

Before configuring Aux and E-Aux analog systems 1) See - “Use AquaManager to configure system inputs and outputs” - page “Use AquaManager to configure System inputs and outputs” on page 150. AND 2) See Control modes [Set point Control Mode and Alarms - page 153 and PID control mode - page 175.]

Please review - Use AquaManager to configure sensor systems - page 150.

- E-AUX**
1. Wire digital input at IOEM for E-Aux system - see IOEM/REM Safety and Installation guide>Chapter 3>Step 5>Wire non temperature IOEM inputs;

AND/OR

1. Wire Aux digital devices - page 56.
2. Wire relay output device to local instrument, or any networked 5X00 instrument - page 54 for local instrument.

AND/OR

2. Wire relay output device to REM - see IOEM/REM Safety and Installation guide>Chapter 3>Step 4>Wire REM Relay Outputs. Wire any output devices to be used for system.

5. Use ▲ ▼ to scroll and highlight submenus.
6. Press ↵ to select.
7. Enable and configure submenus. Configure control and alarm relay(s) using AquaManager - see page 150.
8. Press **Exit Menu** to save configuration and return to Run Screen.
9. Test system output devices at →System→Service→Output Test - page 144 or create an event to verify configured relay(s) energize.

Note:

- **It is important to keep the 5X00 at the Run Screen during normal operation. Alarm functionality (email alarms, activation of enabled alarm relays, alarm icons, and buzzer) is suspended when 5X00 is not at Run Screen.**
- One relay can be assigned to multiple 5X00 systems. It is essential that the relay configuration be verified in order to avoid conflict of operation of wired relay devices. If not configured properly, assigning one relay to multiple systems can result in invalid operation of 5X00.
- E-Aux system datalogs are not accessible at the 5X00. They must be viewed using AquaManager.

Temperature

Menus → Sensor Setup→Aux 3-6
→E-Aux 1-8

Configure temperature system control and alarm low and high values, control and alarm relays and hold off time in the Sensor Setup Menu.

Aux 3, 4, 5 and 6 can be wired and configured for a temperature sensor. Temperature systems are configured differently for 5400 and 5500D instruments. The differences are explained below.

E-AUX E-Aux systems can be configured to use an IOEM channel as a temperature input. See IOEM/REM Safety and Installation guide for wiring and input channel configuration. E-Aux temperature sources cannot be associated with DO systems for temperature compensation.

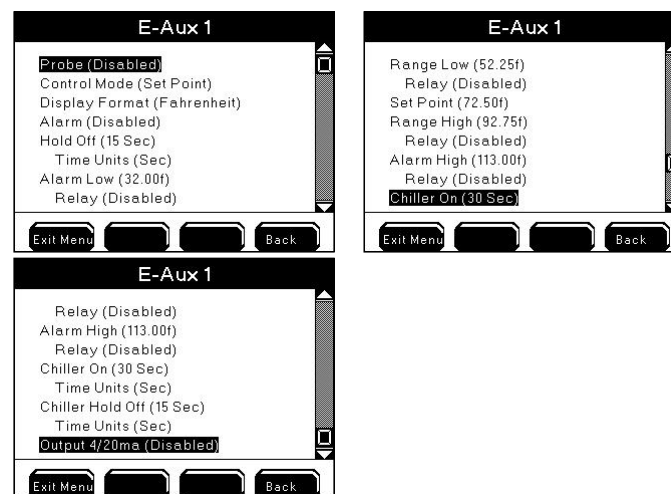

5400 5400 only - Aux configured temperature systems can be configured as the temperature compensation source for any of the four DO channels. Aux configured temperature systems can also be configured as independent temperature systems at any location in the system stream.

5400 Configuration of the DO temperature source is done in the DO Sensor Setup menu - page 173.

5500 The 5500D-01, 5500D-02 and 5500D-04 temperature systems can be configured based on either the aux temperature sensor or the ODO temperature sensor. Aux configured temperature systems can only be configured as independent temperature systems. The DO system temperature compensation value is always taken from the temperature sensor in the ODO probe.

5500 Configuration of the DO temperature source is done in the System → Configure Aux →Temp SourceAux 3-6 .

Configure Temperature System Aux 3-6

Before configuring E-Aux temperature systems 1) See - “Use AquaManager to configure system inputs and outputs” - page 150 AND 2) See Control modes [Set point Control Mode and Alarms - page 153 (E-Aux temperature set point control mode can operate in normal or timed mode - page 157) and PID control mode - page 159.]

1. Wire temperature sensor to 5X00 I/O Board (for non ODO sensor temperature system) - page 52.

- Wire relay output device(s) to local instrument, or any networked 5X00 instrument - page 54.

OR

- Wire relay output device to REM - see IOEM/REM Safety and Installation guide>Chapter 3>Step 4>Wire REM Relay Outputs.
- Configure “temperature” input type (for non ODO sensor temperature system) at

Menus → System → Configure Aux → Input Type

- Configure temperature source :

Menus → Sensor Setup → DO 1-4 → Temp Source → User Defined
→ Aux 3-6

5400

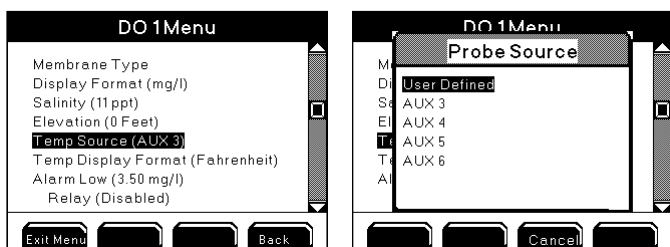

OR

5500

Menus → System → Configure (Aux 3-6 only) → Temp Source → Aux Input
→ ODO Probe

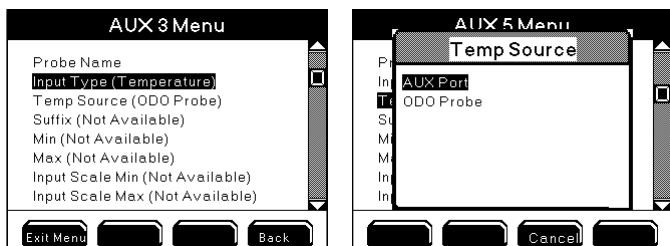

- Enter Aux 3-6 in Sensor Setup menu to configure temperature system:
Menus → System → Sensor Setup → Aux 3-6 (Temperature 1-6)

- Configure Control Mode see 152.

Menus → System → Sensor Setup → Set Point Control
→ PID/PWM Control

- Use ▲ ▼ to scroll and highlight submenus.

- Press to select.
- Enable and configure submenus. See Control Modes and Alarms for menu functionality - page 152. Use AquaManager to configure sensor setup menus - page 150.
- Optional - Configure digital 4/20mA output - page 178.
- Press to save settings and return to Run Screen.
- Test system output devices at → System → Service → Output Test - page 144 or create an event to verify configured relay(s) energize.

Configure Temperature System E-Aux 1-8

Before configuring E-Aux temperature systems 1) See - “Use AquaManager to configure system inputs and outputs” - page 150 AND 2) See Control modes [Set point Control Mode and Alarms - page 153 (E-Aux temperature set point control mode can operate in normal or timed mode - page 157) and PID control mode - page 159.]

E-AUX

- Wire temperature input at IOEM for E-Aux system - see IOEM/REM Safety and Installation guide>Chapter 3>Step 5>Wire IOEM inputs;
- Wire relay output device to local instrument, or any networked 5X00 instrument - page 54 for local instrument.

OR

- Wire relay output device to REM - see IOEM/REM Safety and Installation guide>Chapter 3>Step 4>Wire REM Relay Outputs. Wire any output devices to be used for system.

- Configure Input Type at Menus → System → Configure E-Aux → Input Type and other fields - page 108.

- Enter E-Aux 1-8 in Sensor Setup menu

Menus → System → Sensor Setup → E-Aux 1-8

- Use ▲ ▼ to scroll and highlight submenus.

- Press to select.

E-AUX

- Enable and configure submenus. Configure IOEM Source and Channel. Also see Control Modes and Alarms for menu functionality - page 152. Use AquaManager to configure sensor setup menus - page 150.

- Optional - Configure digital 4/20mA output - page 178.

- Press to save configuration and return to Run Screen.

- Test system output devices at → System → Service → Output Test - page 144 or create an event to verify configured relay(s) energize.

Notes:

- It is important to keep the 5X00 at the Run Screen during normal operation. Alarm functionality (email alarms, activation of enabled alarm relays, alarm icons, and buzzer) is suspended when 5X00 is not at Run Screen.**

- The Configure Aux menu will display temperature configured channels as “disabled”. This is because aux systems configured as temperature channels no longer function as analog aux channels, but rather function as a temperature sensor system.

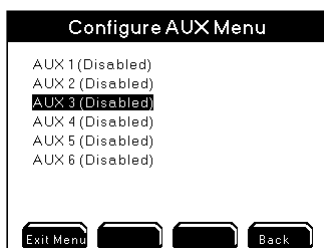

- The Sensor Setup menu - page 138 is automatically enabled when an aux 3-6 channel is configured for temperature.

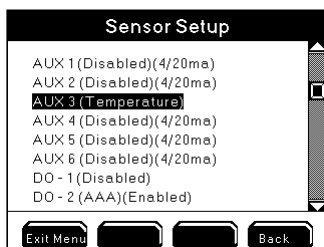

- Aux temperature, E-Aux and ODO temperature values are not accessible at the 5X00. Temperature readings can only be obtained using AquaManager. Readings will be shown in the AquaManager datalog in either °C or °F based on the user configured temperature display format.
- Celsius temperature set point, control, and alarm values are configured to the 10ths place. Fahrenheit values are configured to the 100ths place; however, fahrenheit display values and temperature system operation are based on values truncated to the 10ths digit.
- See *30 Second Sensor Hold Off* - page 163.
- Temperature display format (°C or °F) is user selectable. Changing the temperature units automatically adjusts set points to new temperature units.
- Temperature readings are stored in the sensor data log in °C regardless of display format.
- Temperature values affect DO readings. It is important that the temperature sensor is reporting accurately.

- 5400** - When disabling an aux temperature system that has been assigned to a DO channel, be sure to reconfigure the user defined temp source or enable another aux temperature source for that DO system.

DO 1-4

Menus → Sensor Setup → DO 1-4

Salinity & Temp Compensation for DO Measurements

In order to report accurate DO values, the salinity and temperature of the water around the sensor must be known and compensated for. For accurate DO mg/L readings, the salinity value of the water being monitored should be entered as a ppt (parts per thousand) value in the DO salinity menu.

- 5400** Each DO system uses the temperature value from the configured temperature sensor or user defined value entered in the DO sensor set up temperature source menu. Aux temperature systems can be assigned to any of the four DO systems.

- 5500** The DO system temperature compensation value is always taken from the temperature sensor in the ODO probe.

Notes:

- Changes to salinity affect DO mg/L value.
- Changes to salinity do not affect DO % sat values.
- 5400** - Configure a temperature source or enter a user defined value for each enabled DO system. Verify that the configured temperature value or assigned temperature sensor is accurate for the water system being monitored around the DO sensor.

Two Range Controls for DO

Each 5X00 DO sensor input has two low and two high control ranges when in Set Point Control mode. This dual range allows for more control over oxygen levels in the water system. Example - DO Set Point Control range low control becomes active causing the air injection system wired/configured to relay #1 to energize. DO levels continue to fall, activating range low control two a pure oxygen injection system wired and configured to relay #2.

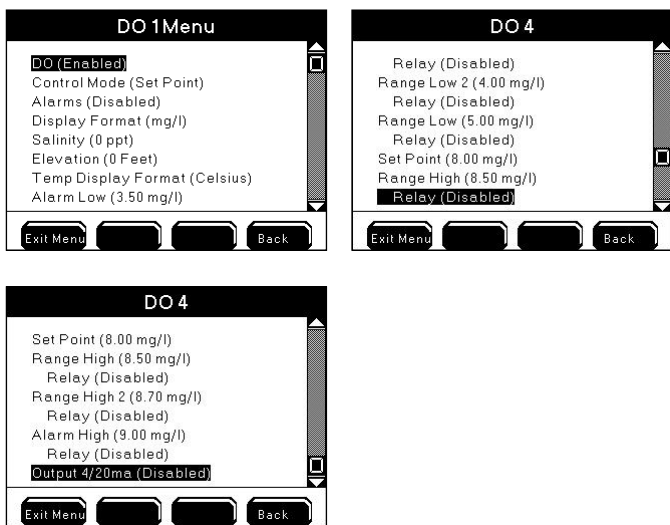

Configure DO Systems

Before configuring E-Aux temperature systems 1) See - “Use AquaManager to configure system inputs and outputs” - page 150 AND 2) See Control modes [Set point Control Mode and Alarms - page 153 (E-Aux temperature set point control mode can operate in normal or timed mode - page 157) and PID control mode - page 159.]

1. Install and wire DO probe(s) and membrane and/or sensor cap - 49.
2. Wire relay output device to local instrument, or any networked 5X00 instrument - page 54.

OR

2. Wire relay output device(s) to REM - see IOEM/REM Safety and Installation guide>Chapter 3>Step 4>Wire REM Relay Outputs.
3. Configure DO system temperature source :

5400

Menus → Sensor Setup → DO 1-4 → Temp Source → User Defined → Aux 1-6

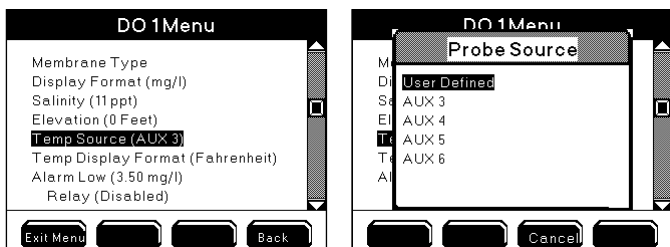

OR

5500

Menus → System → Configure (Aux 3-6 only) → Temp Source → Aux Input → ODO Probe

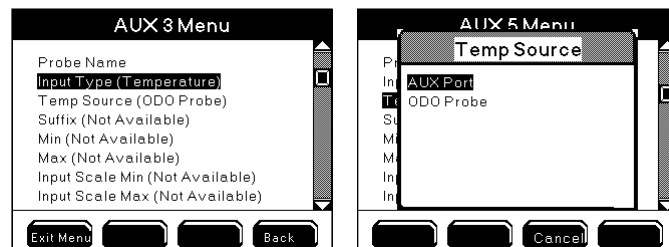

4. Configure Control Mode - 152.
Menus → System → Sensor Setup → Set Point Control → PID/PWM Control
5. Use ▲ ▼ to scroll and highlight submenus.
6. Press ↵ to select.
7. Enable and configure submenus. See Control Modes and Alarms for menu functionality - page 152. Use AquaManager to configure sensor setup menus - page 150.
8. Optional - Configure digital 4/20mA output - page 178.
9. Press Exit Menu to save settings and return to Run Screen.
10. Test system output device(s) at → System → Service → Output Test - page 144 or create an event to verify configured relay(s) energize.

Note:

5500

- Elevation data can only be viewed and configured locally at the 5500D instrument and cannot be viewed or configured using AquaManager.

PID 4/20mA and PID/PWM control mode menus at instrument

All non digital sensor systems can be configured for PID/PWM or PID 4/20mA control mode.

See PID/PWM and PID 4/20mA Control Mode - page 175 before configuring sensor systems.

5X00 instrument run screen when IOEM input value is invalid

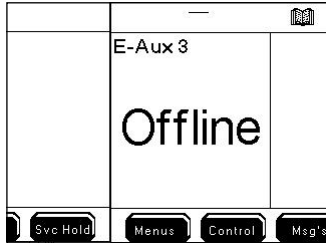

Configure sensor system as a 4/20mA output

5X00 sensor systems input values (DO %sat, DO mg/l, aux and E-aux) can be converted to a 4/20mA output signal that can be sent to an external device, such as a PLC. This is done by wiring and configuring an IOEM channel as a 4/20mA output. Please see IOEM/REM Safety and Installation Guide for wiring and hardware configuration information. AquaManager must be used to configure a sensor system as a 4/20mA output. While the 4/20mA output menus can be viewed at the instrument, entering a specific menu results with an information window stating “4-20mA out can only be changed in AquaManager”.

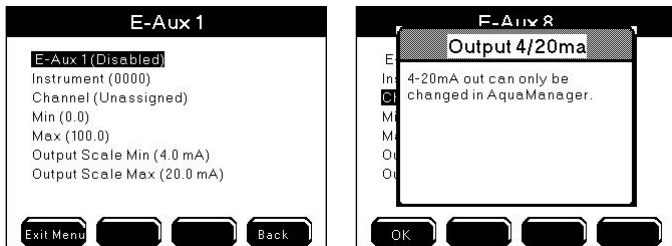

4/20mA menu configuration information is provided at AquaManager Help. See AquaManager Help contents>working with nodes>expansion modules>ioem expansion module>configure ioem 4mA-20mA output to a 5X00 system bookmark. Configure 4/20mA outputs at sensor system tabs in AquaManager. 4/20mA configuration fields are located at the bottom of all sensor system tabs.



AquaManager and the Sensor Setup Menu

All Sensor Setup menus can be configured using AquaManager. After polling the 5X00 node, use “Systems Management” to view and upload 5X00 configuration.

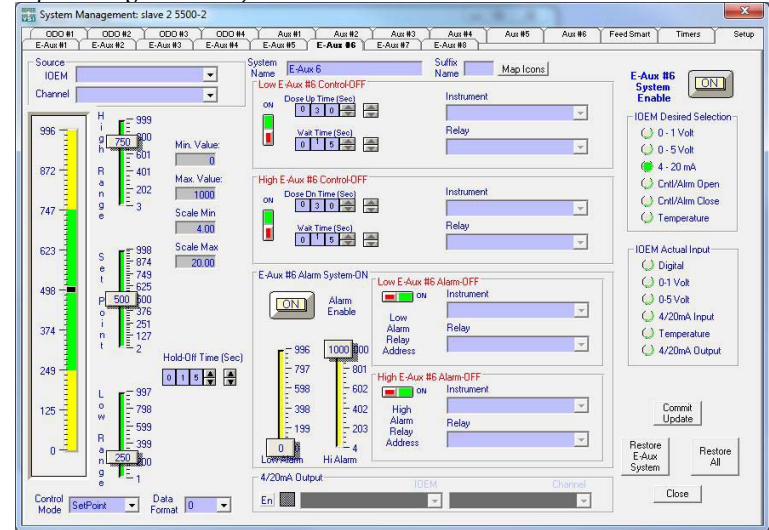

AquaManager E-Aux system tab

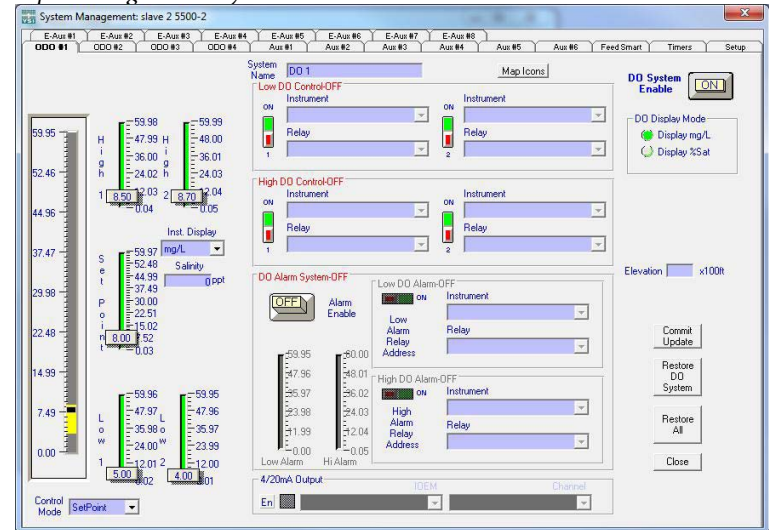

AquaManager ODO system tab



Notes:

-  - Always manually poll the 5X00 after uploading configuration changes and verify that the uploaded information is retained at the 5X00. When configuration changes are uploaded using AquaManager at the same time configuration changes are being made by a user in the menus on the 5X00, AquaManager uploads may not be saved depending on the timing of keystrokes at the 5X00.
-  - **The Run Screen must be displayed during normal operation.** If the 5X00 is not at the run screen during AquaManager uploading, pressing  at the 5X00 may \only save certain configuration changes.

See *Chapter 5 AquaManager* - page 197 and *AquaManager online help* for additional information.

Timers

The 5X00 has four daily ten event timers. Timers can be configured to control various hardware devices. In addition, there are four Feed Smart™ feed timers.

Timers 1-4

Menus → Timers→Timer 1-4

Configure up to 40 daily timer events using the 10 events of Daily Timer systems 1-4. Timer events occur on a daily basis until either the start time is cleared, the timer

system is disabled, or the relay is disabled. Timer icon  displays at systemwide icon location at the Run Screen when timer relay is active .



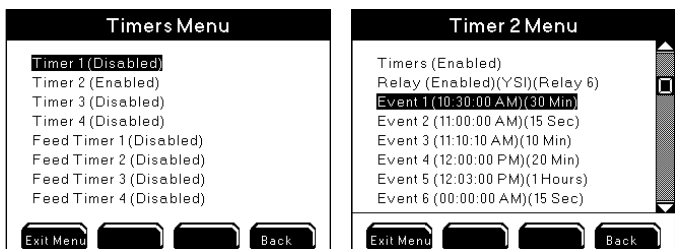

Directions to Configure Timers 1 - 4



Please review - Use AquaManager to configure sensor systems - page 150.

1. Install and wire timer device(s) or any networked 5X00 instrument - page 54.

OR

1. Wire relay output device(s) to REM - see IOEM/REM Safety and Installation guide>Chapter 3>Step 4>Wire REM Relay Outputs.
2. Enter Timer 1-4 menu
Menus →Timers
3. Use  and  to scroll and highlight submenus.
4. Press  to select.
5. Enable and configure submenus.
6. Press  to save configuration and return to Run Screen.

Notes:

- **Timer system must be enabled in order to energize the configured timer relay.**
- Press  to display timer events.
- Timer events with overlapping times occur as follows. Example - event 1 starts at 10:15 for 25 minutes, event 2 starts at 10:25 for 25 minutes; relay turns on at 10:15, relay turns off at 10:25, relay turns on at 10:25, relay turns off at 10:50.
- Configure “0” duration time to disable any of the 10 timer events.
- Timers configured over 86399 seconds (seconds in a day) are not valid.
- If a timer is active (relay energized), the timer is NOT recalculated when the 5X00 time and/or date is changed. Once a timer has been turned on, it runs for it’s configured duration and does not reset it’s run time based on changes made to 5X00 time. Example - Timer 1, event 1 is configured to come on at 9:00am for 10 minutes. Timer relay energizes at 9:00am. At 9:05am, the 5X00 unit time is changed to 10:05am (for daylight savings adjustment). The timer relay will de-energize after five additional minutes. Unit time will be 10:10am. The event log will reflect the unit time when the event occurred. In this example, 9:00am for the start time and 10:10am for the end time.
- If a timer is active (relay energized) and 5X00 is put on service hold, the relay will not reenergize after service hold expires regardless if timer time has not expired. There is only one “on” time for all timers. Turn the 5X00 off, then on, to reset the timer system. A timer relay will energize for the configured time duration and not for the remainder of time prior to service hold. Example - timer relay 1 is configured to start at 11:00 am for one hour. Service hold is enabled and configured for 5 minutes. The timer relay energizes at 11:00 am. At 11:15 am, the 5X00 is put into service hold. Timer relay 1 de-energizes. At 11:20 am, the service hold time expires. The 5X00 is power cycled and the timer relay energizes after 30 seconds. The timer relay de-energizes at 12:20 pm and not at 12:00 pm which would have been the original off time if the unit had not been placed in service hold.
- Energized timer relays de-energize at downloader. The relay will reenergize after a power cycle following the downloader if the timer system is still active.

Timer relay will energize for entire configured duration time and not for the remainder of time prior to being placed in downloader. There is only one “on” time for all timers. Example - timer relay 1 is configured to start at 11:00 am for one hour. The timer relay energizes at 11:00 am. At 11:15 am the 5X00 is put into downloader. Timer 1 relay de-energizes. Timer 1 relay re-energizes 30 seconds after a power cycle following the downloader (at approximately 11:24 am). The timer relay de-energizes at 12:24 pm and not at 12:00 pm which would have been the original off time if the unit had not been placed in downloader.

- If power fails when a timer is energized and the power is restored when the timer system is still active, the timer relay will energize for the timer duration and not for the remaining original timer cycle. Example - timer one is configured to start at 10:40 for one hour. The power fails at 11:30. Power is restored at 11:35. The timer will energize for one hour, not the remaining 5 minutes of the original timer cycle.
- When the timer relay is energized after the timer duration is changed, the timer relay de-energizes and reenergizes for the newly configured duration and not for the remaining original timer duration. Example - timer one is configured to turn on at 8:30 am for 10 minute duration. Timer one relay energizes at 8:30 am. At 8:35 am, timer one duration is changed to 20 minute. Timer one relay de-energizes at 8:35 am and re-energizes for the newly configured 20 minute duration.
- When the timer start time and duration are reconfigured and fall within the current 5X00 unit time, the relay energizes for the entire duration. Example - The 5X00 unit time is 8:30 am. Timer one is configured to turn on at 8:00 am for one hour. The timer relay will energize at exit to run screen and will remain energized for one hour. The 5X00 does not use the system clock to calculate duration in this case. The following day, the relay will energize at 8:00 am, and de-energize at 9:00 am.
- There is a 30 second delay at power up before timers become active.
- Timer relay off times drift by < .2%. when duration is longer than 5 minutes. The drift increases the relay ‘on’ time.

Feed Smart™ Timers 1-4

Menus → Timers → Feed Smart™ Timer 1-4

The 5X00 has four feed timers. In order to configure feed timer(s) correctly, it is important to understand how the 5X00 functions based on the feed timer configuration. The Feed Smart™ Timer system must be calibrated prior to use. For proper operation, the Feed Timer System requires the user to enter the total amount of food to be dispensed, number of feedings to dispense the food, and a defined time period within which the feedings will occur. The Feed Timer can be configured to operate for any or all days of the week and includes continuous or timed feeding

modes, FCR (feed conversion ratio), and sensor options.  icon is displayed when any Feed Smart™ timer relay is energized.

The following definitions are used in regard to the Feed Smart™ Timer system:

- feed cycle - amount of time that all feeds occur in:
 - continuous - feedings occur over 24 hour per day period;
 - timed - feedings occur only between configured start and end times;
- feed duration - length of time feeder relay is energized;
- feed interval - length of time between feedings.

Optional Sensor control reduces the amount of food dispensed if DO or temperature measurements are “out of range” per user defined configuration. The FCR (feed conversion ratio) feature automatically computes and increases the daily amount of food dispensed per FCR configuration.

Notes:

- It is important that the 5X00 be configured with valid data. The feeder system will not operate properly if, for example, the daily weight of food is greater than can be dispensed in the defined feed cycle.
- Disable the feed timer system when changing configuration and/or when performing a calibration. Enable the feed timer system after configuration changes and/or calibration has been done. The feed timer system recalculates duration and interval times based on the new configuration. Press  after disabling the feed timer system and before making configuration/calibration changes.

Feed Mode

Continuous

Menus → Timers → Feed Smart Timer → Feeder → Feed Mode → Continuous

When the feed timer is configured for continuous feed mode, feedings occur throughout the day. Feed duration and interval are determined by the daily total weight of food, number of feedings, and test calibration data. Optional Sensor control and FCR configuration can also effect feed duration.

Example of Feed Timer Configuration and Test Calibration Data:			
Feed Mode Continuous (86500 seconds in 24 hours), feed timer sensor control is disabled	daily weight 500 units	daily feedings 100	test calibration data 10 units per 30 seconds
The 5X00 determines feed duration and feed interval for the above feed cycle as follows:			
units fed per feeding:	500 ÷ 100 = 5 units per feed		
feed time duration for each feeding:	if 10 units feed in 30 seconds, then 5 units will feed in 15 seconds 30x5 ÷ 10 = 15		
determine total time feed relay will be energized over 24 hour period:	15 units X 100 feeds = 1500 seconds		
determine feed interval:	86500 - 1500 = 84900 ÷ = 100 (number of feeds) = 849 seconds, 60 = 14.15 minutes, or 14 minutes and 9		

Notes:

- Once Continuous feed has been configured, the 5X00 determines any remaining feeds for the 24 hour period ending at 23:59. In continuous feed mode, the feed cycle always begins at 00:00 (midnight). Start and End time fields are not available for Continuous feed mode.
- In continuous feed mode, feeding(s) will end after the last completed feeding that ends prior to 11:59 pm (23:59) of an enabled day when crossing midnight to a disabled day. Feeding(s) will resume at 12:00 am (00:00) for the next enabled day.

Timed

Menus → Timers → Feed Smart Timer → Feeder → Feed Mode → Timed

Feedings occur only during the start and end times on “enabled” days of the week. In timed mode, the 1st feeding occurs at the start time of the feed cycle. The last feeding completes by the end time. Feed duration and interval are determined by the daily total weight of food, number of feedings, and test calibration data. Optional Sensor control and FCR configuration also effect feed duration.

Example of Feed Timer Configuration and Test Calibration Data:			
Feed Mode Timed, Start Time: 8 am, End Time: 10A feed timer sensor control is disabled	daily weight 500 units	daily feedings 5	test calibration data 10 units per 30 seconds
The 5X00 determines feed duration and feed interval for the above feed cycle as follows:			
units fed per feeding:	500 ÷ 5 = 100 units per feed		
feed time duration for each feeding:	if 10 units feed in 30 seconds, then 100 units will feed in 300 seconds 30x10 = 300		
Total feed duration over 2 hour period	300 seconds X 5 feeds = 1500 seconds		
determine feed interval:	7200 seconds (seconds in 2 hours) - 1500 (feed duration seconds for 2 hour) = 1140 seconds ÷ 60 = 19 minute intervals		

Notes:

- If a timed feed cycle includes feed times that cross midnight, the feed cycle ends prior to 11:59 pm (23:59) of the enabled day when crossing midnight to a disabled day. Feeding(s) will resume on next enabled day. Example - if Tues through Sat are enabled days and the start time is configured for 10:00 pm (23:00) and the end time is configured for 01:00. On a Saturday, the feed cycle would start at 10:00 pm (23:00). The last feed occurs by 11:59 pm (23:59) on Saturday since Sunday is a disabled day. The next feed occurs at 12:00 am (0:00) on Tuesday. This feed cycle would end at 01:00 on Tuesday. No feeding occurs Monday, because Monday is a disabled day.
- The Feed timer will not operate properly if the start date is set prior to January 1, 2007.

Daily Weight

Menus → Timers → Feed Smart™ Timer → Feeder → Daily Weight

The daily feed amount is the total weight of food that will be dispensed over the feeding cycle. The value is user selectable from 1 to 100000. The Feed Timer system divides the total daily feed amount by the number of daily feedings and uses the calibration/test data to determine feed duration and interval times.

Daily Feedings

Menus → Timers → Feed Smart™ Timer → Feeder → Daily Feedings

Configure the number of feedings to occur in feed cycle. The value is user selectable 1–255.

FCR

Menus → Timers → Feed Smart™ Timer → Feeder → FCR

The optional FCR (feed conversion ratio) feature automatically increases the amount of food dispensed over a feed cycle. The increase in the amount of food is based on the user configured increase in biomass over a 24 hour period. Biomass and daily (feed) weight amounts are adjusted by the 5X00 prior to the 1st feed “on” time of a scheduled feed cycle occurring after midnight.

Notes:

- With FCR enabled and properly configured an event occurs when the 5X00 time crosses midnight. See below.

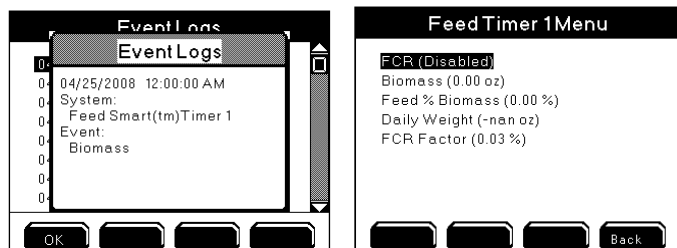

Biomass

Menus → Timers → Feed Smart™ Timer → Feeder → FCR → Biomass

Enter the total weight of livestock being fed at the time FCR is enabled. The value is user selectable 1 to 100000.

Feed % (of) Biomass

Menus → Timers → Feed Smart Timer → Feeder → FCR → Feed % Biomass

Enter the percentage of the total livestock weight (biomass) that will be used to determine the daily feed weight. The value is user selectable 0.0–99.9%.

Daily (Feed) Weight

Menus → Timers → Feed Smart Timer → Feeder → FCR → Daily Weight

Configure the initial daily feed weight by multiplying the biomass amount by the Feed % Biomass percentage (the 5X00 will not calculate the initial amount). Example—if the biomass is 1000 and the feed % biomass is 3%, the initial daily feed weight amount is 30. On each following day, the 5X00 will use the biomass value along with the feed % biomass to calculate the new daily feed weight amount.

Note:

- The initial daily weight value must be calculated as described above. Configuring an invalid initial daily weight will result in incorrect biomass and daily weight calculations when the 5X00 crosses midnight.

FCR Factor

Menus → Timers → Feed Smart Timer → Feeder → FCR → FCR Factor

Enter the ratio of the amount of food required versus the corresponding increase in fish weight (biomass). This value is used to automatically increase the biomass amount—as shown in the example below.

	FCR example						
	Day 1	Day2	Day 3	Day 4	Day 5	Day 6	Day 7
Biomass	1000	1020	1040	1061	1082	1104	1126
Feed % Biomass	3%	3%	3%	3%	3%	3%	3%
Daily Feed Amount	30	30.6	31.2	31.8	32.5	33.1	33.8
FCR Factor	1.5	1.5	1.5	1.5	1.5	1.5	1.5
1/FCRX Feed Amount	20	20.4	20.8	21.2	21.6	22.1	22.5
New Biomass	1020	1040	1061	1082	1104	1126	1149

Sensors

Menus → Timers → Feed Smart Timer → Feeder → Sensors

- Disabled/Enabled
- DO Low/High/DO % Change
- Temp Low/High/Temp % Change

Changes in water conditions affect the amount of food fish eat which in turn affects fish growth. With the sensor feature enabled, the feed timer system will verify that DO and temperature values are within user configured ranges. This verification is done immediately prior to starting each feed duration in a feed cycle. If values are reported that fall outside acceptable configured ranges, the feed timer relay energizes for a shorter period (user configured percentage) thereby reducing the amount of food that is dispensed. Feed timer sensor ranges are independent of sensor setup configuration ranges. For timed feed cycles, feed interval for the entire feed cycle is determined by the duration of the first feed.

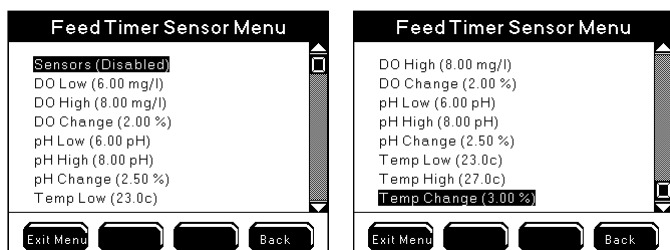

Example - The feed timer is configured as follows: sensor temperature low value is 25.1°C, feed timer temperature change is 9%, timed feed mode, six feeds, daily weight 2 units start time 8A, end time 9A, six 9.999 second feeds of .3333 units each to occur at 9 minute 50 second intervals without sensor reduction. Prior to 8A feed cycle, the start temperature value is reading 24.9°C. Feed duration of 9.999 seconds will be reduced by approximately 1 second (9%) because of the “out of range” temperature value.

Notes:

- 5400 - 5400 - Feed Timer temperature sensor value is always taken from the DO system configured temperature source.
- 5500 - Feed Timer temperature source is always taken from the ODO temperature sensor regardless if temperature system is configured for an aux temperature sensor.

DO Low/Temp Low

Enter the lower limit of the sensor range where no feed reduction will take place.

DO High/Temp High

Enter the high limit of the sensor range where no feed reduction will take place.

DO Change/Temp Change

Enter the percent reduction in feed weight that will occur for “out of range” enabled feed timer sensors. Results from all out of range sensors are added. To disable a sensor value from affecting feed duration configure 0.0% as the % change for that sensor.

Calibrate

Menus → Timers → Feed Smart™ Timer → Feeder → Calibrate

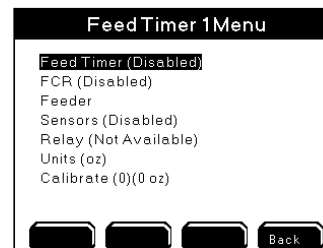

Calibrating the feeder is essential for proper operation of the feed timer system. Feed timer calibration is required to establish the amount of food dispensed over a certain period of time. The 5X00 will base feed cycle duration times on the last saved calibration value.

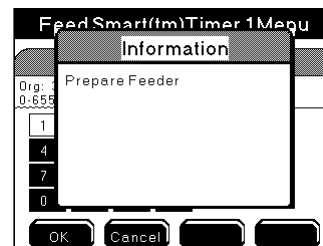

Calibrate Feed Smart™ Timer

1. Install and wire feed timer device. See wire relays - 54.
2. Enable Feed Timer.
Menus → Timers → Feed Smart™ Timer → Feed Timer → Enabled
3. Assign feed timer relay.
Menus → Timers → Feed Smart™ Timer → Relay
4. Calibrate feeder.
Menus → Timers → Feed Smart™ Timer → Calibrate
5. At numeric keypad, enter test run time the feeder relay will energize.



6. Press  for feed timer relay to energize for configured run test time. Countdown of relay “on” time is displayed.
7. When run time expires, the relay de-energizes. Enter the amount of food dispensed at the Measured Weight screen.
8. Press  to save settings and return to Run Screen.

Notes:

- Since feeders and food size vary, run several calibrations and enter the average weight at the last calibration. If feeder or feed type is changed, recalibrate the feeder.
- If no test/calibration has been performed or if the results have not been saved, the 5X00 will be unable to perform any feeding(s) because there will be no reference to determine the rate at which feeding(s) will occur.
- Stored calibration data is available from the AquaManager program.
- If feed timer units change, the feeder must be recalibrated.
- If an incorrect value is entered and saved, another calibration must be performed.
- Disable feed timer system when performing feed timer calibration, de-energizing any active feed timer relay.
- After calibration is complete, press **Exit Menu** to Run Screen. The Feed timer system resets based on new calibration configuration.
- Feed Timer calibration cannot be done using AquaManager.

AquaManager and the Timer Menu

Most Timer menus can be configured using AquaManager. After polling the 5X00 node, use “Systems Management” to view and upload 5X00 configurations. Select the Feed Smart™ and Timers tabs to view and change configuration.

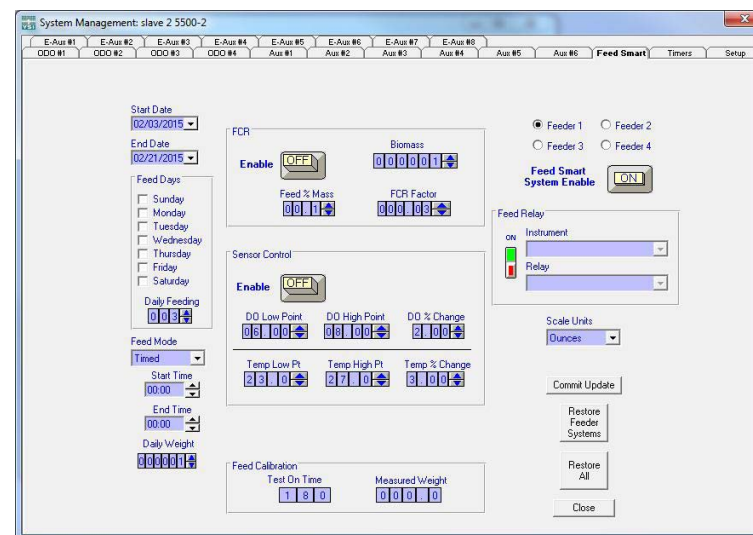
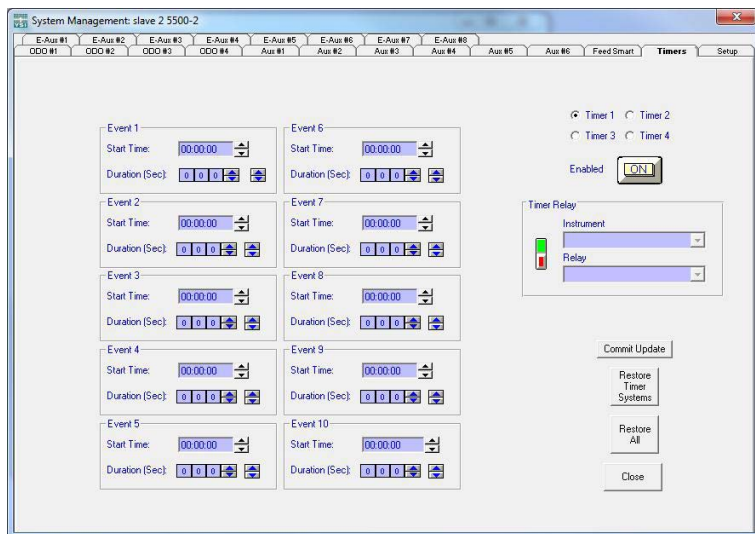

Notes

- Always manually poll the 5X00 after uploading configuration changes and verify that the uploaded information is retained. When configuration changes are uploaded using AquaManager at the same time configuration changes are being made by a user in the menus at the 5X00, AquaManager uploads may not be saved depending on the timing of keystrokes at the 5X00.
- **The Run Screen must be displayed during normal operation.** If the 5X00 is not at the run screen during AquaManager uploading, pressing **Exit Menu** at the 5X00 may only save certain configuration changes.

See *Chapter 5 AquaManager* - page 197 and *AquaManager Online Help* for additional information.

Control Menu

Press **Control** at the Run Screen to display a list of energized sensor and aux 5X00 system relays. The Control menu identifies the active sensor or aux system and control and/or alarm condition. See Control mode and alarms - page 152 for additional information.

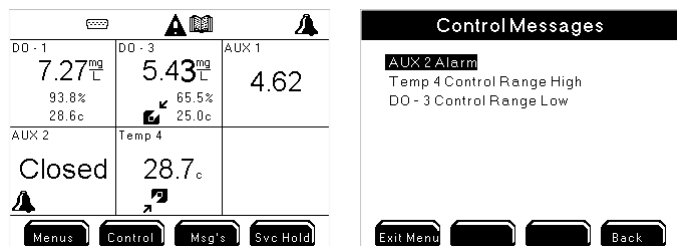

Notes:

- Press **Msg's** to display time stamped detail of control and alarm relay(s).
- Alarm message appears at the Control menu for aux and sensor systems when alarms are enabled regardless if an alarm relay is assigned.
- Active timer (10 event timer and feed timer) systems are not displayed at control menu.
- General alarm systems are not displayed at the Control menu regardless if general alarm relay is enabled.
- Use **▲ ▼** to scroll list when scroll bar appears at window.

When no 5X00 control or alarm system(s) are active, the below screen is displayed.



Msg's Menu

Calibration, Sensor, and Event logs contain 5X00 system information. The 5X00 Sensor log stores 2000 records. The Calibration log stores 500 records. The Event log stores 1250 records. Once the log memory is full, the oldest records are overwritten with more recent records. The number shown in () at the Msg's menu reflects the total number of records in the log. The 25 most recent records for each log are displayed at the **Msg's** menu. Use **▲ ▼** to scroll and press **↩** to view time stamped detail record.

Use AquaManager to capture all records from 5X00 logs and store them to a PC database. Polling times should be determined by logging intervals. Example - if the sensor log is recording values every minute and the sensor log holds 2000 records, polling should occur at least every 33.3 hours. This allows for all records to be saved to the PC before being overwritten on the 5X00. Set the data log interval so that analyzing data based on the configured interval will be helpful. Poll at intervals that don't result in gaps in data.

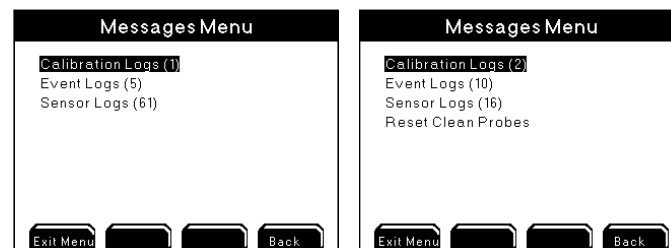

A Reset Clean Probe message will appear at the Msg's Menu if the clean probe timer expires. Selecting "Yes" at "Are you sure?" resets the clean probe timer to the user configured number of days.



Note:

- User configured sensor and relay names do not appear in log menus.

Calibration Logs

Calibration logs store sensor calibration data. Calibration logs are date and time stamped and contain sensor and calibration information for completed calibrations.

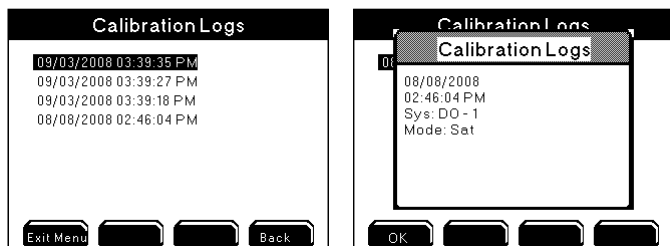

Certain calibration data is not available at the 5X00. Use AquaManager to view and save calibration data to a PC. In addition to sensor system, time, date, and calibration method, AquaManager calibration logs include user input 1, user input 2, and the original and new slope/offset information when applicable.

Event Logs

Control, Alarm, and Timer relays assigned to 5X00 systems create events when they energize and de-energize. In addition, AC power fail, ethernet failure to initialize errors and mode network failures create events. These events are recorded in the Event log. Events identify the 5X00 system, are time stamped, and record relay on and off times (if applicable). The General Alarm does not create an event or control message unless a General Alarm relay is enabled.

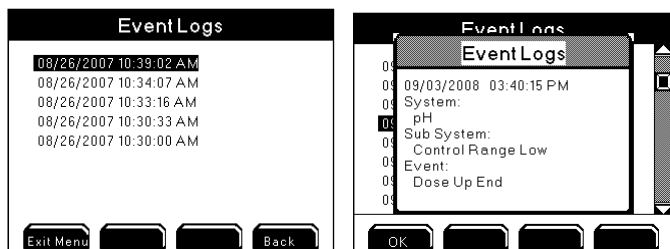

Note:

- Enable event logging in the System menu. See *Event Logging* - page 120 for additional information.
- E-Aux system event logs are stored at the local instrument whose E-Aux

system is being used and not at the device whose output is creating the event. For example - if an IOEM channel 2, whose slave address is 4, is configured as an E-Aux temperature input for a 5200A (slave 14), and a low temperature control relay output for this slave 14 is configured to a 5500 (master), the 5200A (slave 14) and not the master 5500 records the low temperature control events.

Sensor Logs

Enabled systems record sensor data based on data logging menu configuration. Sensor logs identify sensor system, are date and time stamped, and record sensor value at user configured intervals.

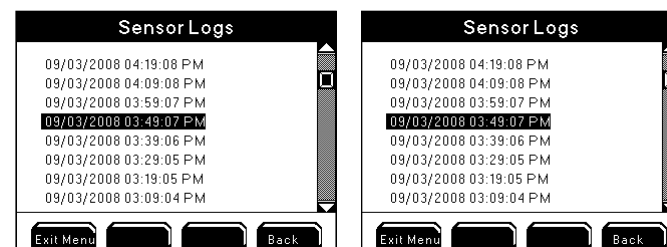

Notes:

- Data logging must be enabled in the System Menu. See *Data Logging* menu-page 118 for additional information.
- 5X00 E-Aux system datalogs are not visible at the instrument.
- AquaManager datalogs must be used to view E-Aux system datalogs;

Svr Hold softkey Button

When servicing sensors or doing tank maintenance, it may be necessary to shut off all systems (including relays) because sensor values will not be accurate. Press **Svc Hold** at Run Screen to enter Service Hold menu. When in Service hold, all relays are de-energized until the Service Hold time expires. The Service Hold time is user selectable. Enable and configure service hold time at **Menus → System → Service Hold - 147..** After service hold time expires or is cancelled, sensor and aux systems are reset causing relays to energize/de-energize based on the system value/condition. Timer systems are not reset. To reset timer systems, turn power off and then on to the 5X00. Press **Exit Menu** to exit Service Hold.

The Run Screen displays a clock count down of the Service Hold remaining time.

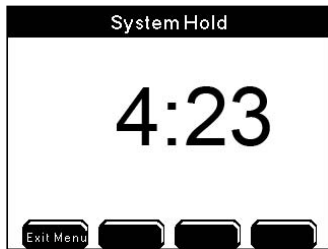

Notes:

- If a timer is active (relay energized) at service hold, the relay will not reenergize after service hold expires regardless if timer time has not expired. There is only one “on” time for all timer systems.
- Entering Downloader mode places 5X00 into Service Hold.
- “Inst. Service Hold” is displayed on any AquaManager map icon associated with an instrument in Service Hold. AquaManager alarm emails are not sent for any alarm condition for a 5X00 that is in Service Hold.
- 5X00 alarm emails are not sent during service hold.



5

AquaManager

-Installing
-Registration

Installing AquaManager

AquaManager provides data logging, graphing, autopolling, mapping, system configuration control, and displays near real-time sensor and aux input values and conditions* at the desktop PC. AquaManager is a valuable tool for remote and local access applications. An extensive online Help system is provided with AquaManager.

*Near real-time - The AquaManager map is updated several times a minute as AquaManager constantly communicates with the nodes during Autopolling using SMS commands. This results in displaying near real-time sensor and aux input values on the map.

One copy of AquaManager per machine is required.

PC requirements and features

AquaManager is a 32-bit Windows application and will run on Windows 2000/XP/Vista/Windows 7 operating systems 32-bit and 64-bit. AquaManager has the following system requirements on your PC:

PC capable of running Windows 2000

- Microsoft Windows 2000 (workstation or server) OR XP (home or professional SP3) OR Vista (SP1) OR 7
- VGA display card
- CD-ROM Drive
- Total RAM installed 16 Megs or greater
- 100 MB of free hard-disk space
- Internet Explorer 7.0, or higher
- Adobe Flash 10b, or higher
- Administrator privileges on PC where application is being installed

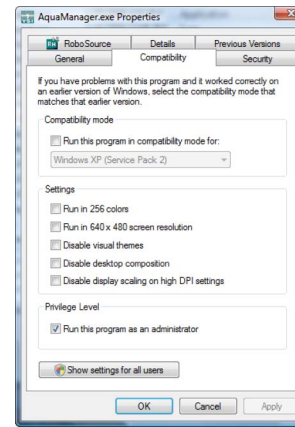

Recommendations:

- Total RAM installed 64 Megs or greater
- 300 MB of free hard-disk space
- latest versions of Microsoft including O/S
- latest version Internet Explorer for AquaManager HTML Help

Software Installation

1. Run AquaManager.exe on the CDROM and follow the instructions in the installation setup.
2. Refer to the README.txt file on the CDROM for additional information on installation and use of AquaManager application.
3. Open application and register. The registration number code is located on the back of CD case.

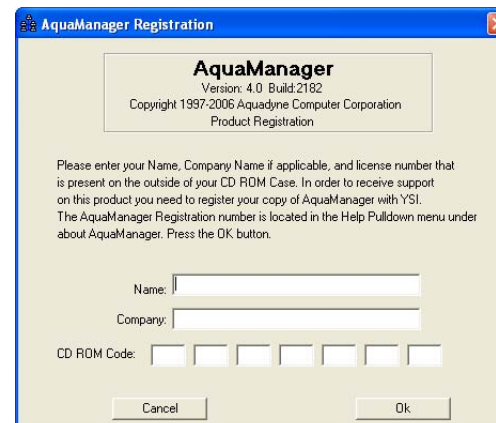

See *AquaManager Online Help* for detailed application configuration information. Before the node can be accessed using AquaManager, perform the following:

4. Create, or Open network;
5. Insert group;
6. Insert node(s);
 - A. Determine communication method;
 - B. Obtain 5X00 serial number(s);
7. Poll node to obtain current node configuration;
8. Complete configuration of node and Aquamanager features for your application.

AquaManager Windows

Use the Explorer and Node Screens to access configuration forms. Certain configuration forms can be assessed in multiple ways. Access to configuration forms is provided below.

Explorer Window

The Explorer Screen is displayed when AquaManager is launched. At the Explorer Screen, the network tree is displayed. The tree includes network, group, and node folder(s), along with node systems that are used for mapping. The tree is represented in hierarchical format.

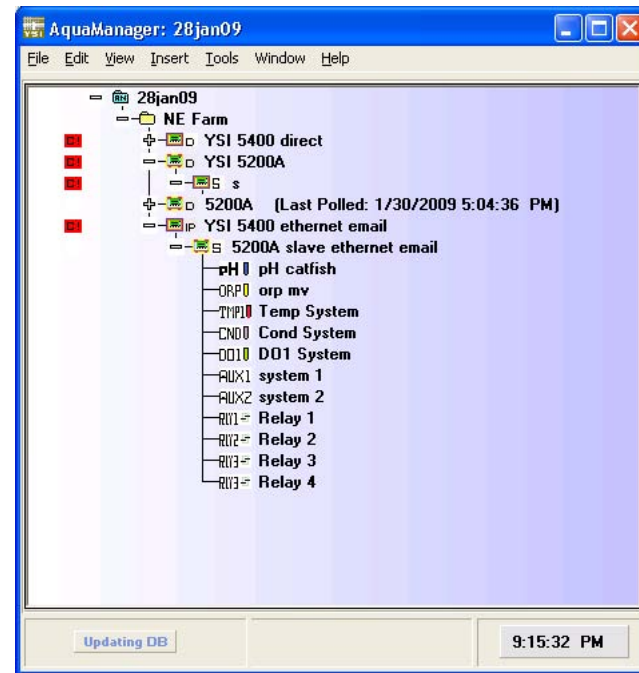

The following configuration and tasks are performed from the Explorer Screen:

- create, open, and export networks
- insert and configure nodes and groups
- edit and view map
- configure system wide properties
- print tree and printer setup
- exit program
- cut, copy, and find node(s)
- delete node or group
- sort nodes in group
- expand and collapse tree view
- access network log files
- insert manual event and manual data into node
- password administration
- launch autopoller
- generate reports
- manual database maintenance
- launch update firmware utility
- configure window display format

- access AquaManager Help
- check for AquaManager software updates
- AquaManager about information

Node (Graph) Window

Double click on a node in tree at the Explorer Screen to open a Node window. A graph is displayed based on the sensor log data received from the last poll. Use graph management and Node Window options to configure the graph display.

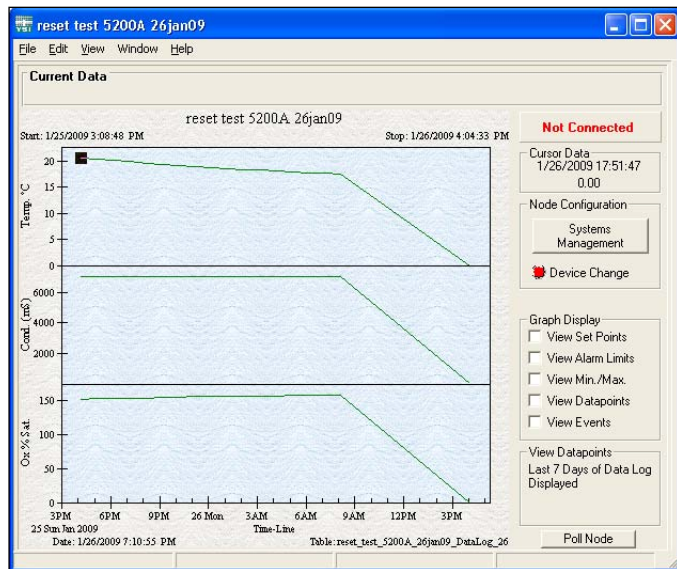

The following configuration and tasks are performed from the Node Window:

- view and configure node properties
- print graph and printer setup
- close node window
- copy graph to clipboard
- insert manual event
- graph management
- customize graph settings
- clear graph overlays
- view data, calibration, event, & configuration event logs
- restore Node Window size to include access to systems management and poll node buttons
- Systems Management access - viewing and uploading configuration to 5X00

- Graph Display options
- Manually poll node button
- Current data is displayed at the top of the graph during a manual poll

Systems Management

To open Systems Management, click on the Systems Management button located to the right of the graph in the Node Window. Use the tabs to view and upload configuration to node. The node configuration displayed is based on last poll.

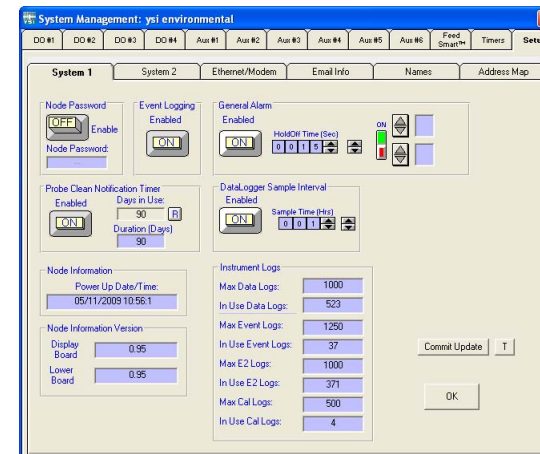

The following configuration and tasks are performed from Systems Management forms:

- view and configure node sensor and aux systems
- view and configure node timer and feed timer systems
- view and configure most node systems (5X00 system menu)
- configure node mapping icons

Notes:

- Always manually poll the 5X00 after uploading configuration changes and verify that the uploaded information is retained. When configuration changes are uploaded using AquaManager at the same time configuration changes are being made by a user in the menus at the 5X00, AquaManager uploads may not be saved depending on the timing of keystrokes at the 5X00.
- **The Run Screen must be displayed during normal operation.** If the 5X00 is not at the run screen during AquaManager uploading, pressing **Exit Menu** at the 5X00 may only save certain configuration changes.

Database Management

For optimal operation and safeguarding, compact and back up the AquaManager database. Uncompacted Access database(s) may become > 1GB when polling large networks and when polling nodes with large data logs. Compact the database from the Explorer Window Tools>Database Maintenance>Compact Database or from the System Wide Properties>Gen. Settings tab.

Configure an automatic weekly backup from the System Wide Properties>Database Backup tab.

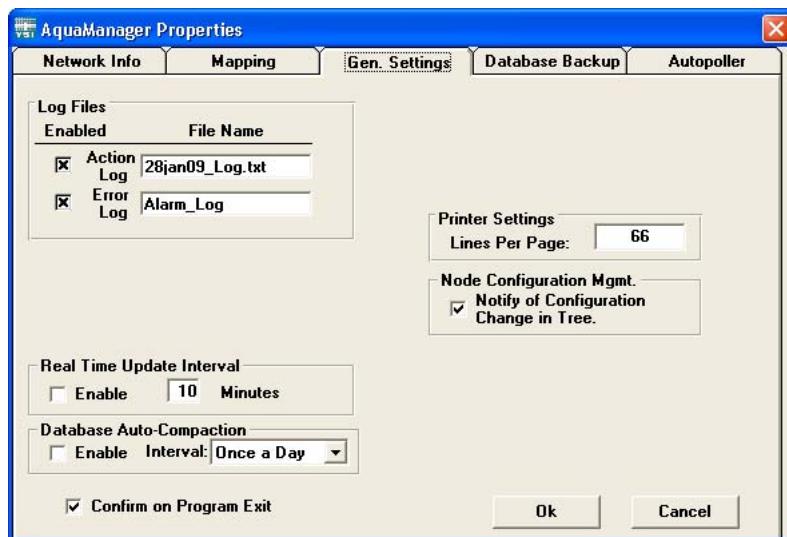

Note:

- Database Auto-Compaction must be enabled in order to access the Backup enable box.

Autopoller

Autopoller is designed to poll node(s) at an interval specified by the user. When the node(s) is polled, new log records and the node configuration are saved to the AquaManager database. Autopoll must be running for the AquaManager email and mapping to operate.

Launch Autopoll at the Explorer Window>Tools>Launch Autopoller.

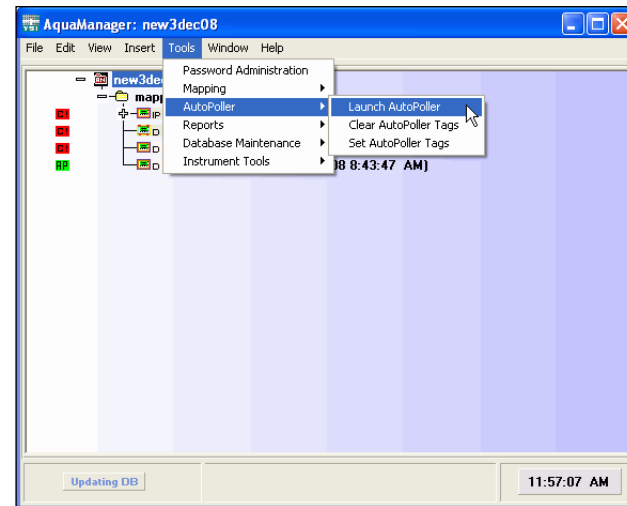

The Autopoller Window opens when Autopoller is launched.

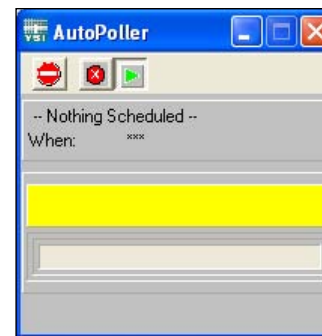

Mapping

Create a network map to display current conditions* for 5X00 nodes at PC running AquaManager. Map icons are configured to represent nodes, node systems, and relays. Map icon images change based on system condition(s). For example, a green icon is displayed when DO-1 is in acceptable operating range, a yellow icon is displayed when DO-1 system is in control range (when enabled), and a red icon is displayed when DO-1 system is in alarm range. This provides a quick visual of system conditions at the PC.

*Near real-time - Map is updated several times a minute as AquaManager constantly communicates with nodes during Autopolling.

Node mapping is available for direct and TCP/IP node communication types.

The following figure is an example of an AquaManager map.

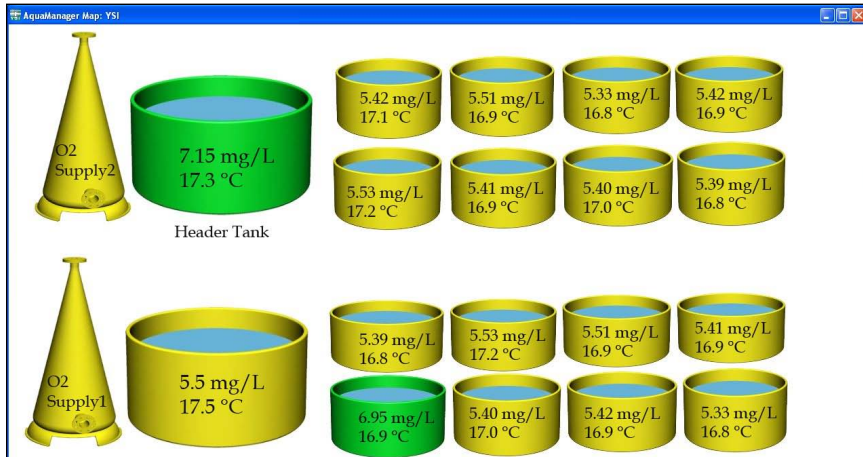

AquaManager Alarm Emails

The PC running AquaManager can be configured to send an alarm email when data received from the node is in alarm range. The alarm range or condition is based on the node configuration. The node configuration is stored in the network database and is verified and updated at each Autopoll SMS communication interval. Autopoller must be running for AquaManager to generate alarm emails. Run Autopoller 24/7 to ensure that alarm emails are sent.

For the AquaManager alarm email to function properly, it may be necessary to send a test email to each email address configured in the Email Alarm List in the Node Properties window. Test emails can be sent in the AquaManager Properties window under the Autopoller tab.

6 Maintenance

- Sensor Calibration Checks
- Sensor Maintenance
- Sensor Storage
- Charging DC batteries
- AquaManager database

Maintenance

It is important to remember that the quality of data is dependent on three factors directly related to the probe:

- General maintenance at the physical deployment site of the probe.
- A well-defined quality assurance program that is carried out on a regular basis to ensure that the sensors are performing properly.
- Proper periodic calibration and maintenance of the specific sensors.

This chapter is designed to provide help in these important areas by providing maintenance tips, help in implementing a quality assurance protocol, and suggested service methods and intervals for the sensors.

Probe Maintenance at the Deployment Site Algae and Debris

A common problem most likely to be encountered with regard to the overall probe deployment is fouling from algae (and other debris). Algae will inevitably collect on any object immersed in water and, unless periodically removed, it can inhibit the sensor's measurement. Once algae build-up occurs on the sensors and/or probe guard, it isolates the sensor's environment from the sample stream. To avoid or minimize this problem, it is necessary to periodically remove the algae from the probe guard and sensors.

Minimizing the Effect of Algae and Debris

The collection of algae on the probe and the frequency of cleaning can be minimized by deploying the probe so that it is angled with (rather than against) the current of the stream. This deployment method will maximize the chances of the algae being swept free of the probe rather than collecting on it.

Remember that no matter what precautions are taken, debris will still collect on the probe and the fouling will have to be removed by periodic cleaning. Cleaning will be easier if the probe mounting method allows for easy removal and replacement of the probe. A little extra time spent on implementing a good mounting arrangement using the optional probe mounting kits will save a lot of time in subsequent cleaning operations.

The frequency with which you will have to remove fouling from the probe varies with the type of water being monitored and the physical deployment of the probe. The need for cleaning can usually be ascertained by visual inspection. You can do no harm by excess cleaning so it is best to remove and clean the probe if any significant fouling is suspected.

Calibration Checks

The sensors are of high quality and should exhibit excellent performance in excess of the warranty period warranty, see 257. However, the dissolved oxygen sensors will inevitably show some drift during deployment due to physical changes of the electrodes, minor fouling of the sensor surfaces, or both of these factors. Inconsistent (fluctuating or noisy) DO sensor readings signal the need for maintenance procedures specific to those sensors. With these factors in mind, it is imperative that you establish and carry out regular quality checks of the sensor readings to ensure that sensor values are being reported accurately and within specifications. The quality checks can help determine when sensor maintenance or calibration is required.

Recommended Quality Assurance Protocol

This product has been designed and tested to provide trouble free service. However, as with all microprocessor based products, there is potential for failure which could cause loss of control functions. Proper QC (Quality Control) procedures can reduce the potential for failure.

It is recommended that you carry out the following quality assurance program weekly during the initial use of the 5X00 system. After several weeks of this program, you should be able to ascertain if this frequency is appropriate for your application. If only minimal drift is observed, then the frequency of quality checks can be decreased. The procedure is relatively simple and should take only about 20 minutes to complete.

1. Take the following items to the deployment site:
 - bucket for clean water to rinse sensors
 - small brush supplied with the conductivity sensor
 - calibration/storage cup supplied with the probe/cable assembly
 - solution and/or secondary instrument to verify values displayed by sensor. See Calibration starting on 81.
 - latex gloves
2. Disable any system control and/or alarm relays that may become active as a result of value(s) generated during the validation process. For example if a DO system is configured to energize a control low relay at ≤ 5.5 mg/L and sensor validation is being made by placing the sensor in mg/L solution ≤ 5.5 mg/L, the control low relay will energize and may adversely affect the DO water system based on the mg/L solution value and not the system stream.
3. Place the 5X00 in Service Hold mode. See 147 and 196 for Service Hold information.

4. Remove the probe from the sample stream.
5. Remove the probe guard from the 5422 and 626250 probes.
6. Manually remove any debris from the sensors and then rinse the sensor carefully in a bucket of clean water, being very careful not to damage the sensor and membrane or cap.
7. Inspect the dissolved oxygen membrane for obvious holes or tears. Do not remove the membrane at this time.
8. Replace the probe guard on the 5422 and 626250 probes.
9. Exit Service Hold if Service Hold timer has not expired. See pages 147 and 196 for Service Hold information .
10. Place the sensor in its calibration environment, i.e. 100% water-saturated air. This can be accomplished by placing the 5422 and 626250 sensor in the calibration/storage sleeve containing a moist sponge. For the 5420 or 5421 sensor, place the sensor in air removing any water droplets on the membrane.
11. Wait about 5 minutes for temperature equilibration and then record the dissolved oxygen reading in percent air saturation as shown on the 5X00 display.
12. If the dissolved oxygen readings show minimal calibration drift (i.e., within about 5% of the correct value) and the readings are stable, proceed to Step #14. If excessive drift is noted or the readings are jumpy, replace the membrane cap as described in the instruction sheet included in the Membrane Kit.
13. After replacing the membrane, calibrate the DO sensor. See calibrate DO sensor starting on page 83.
14. Place the probe back in the sample stream and continue monitoring.
15. Test all control and alarm relays for proper operation.

NOTE: This procedure does not include quantitative data taken with regard to the temperature sensors. The temperature sensor only fails in very rare circumstances and, if it does fail, the temperature readings will seem unreasonable for the current conditions. In the unlikely event that the temperature sensor shows unusual and/or jumpy readings, it will need to be checked by a YSI authorized service center. No user service is possible.

Alternative Quality Assurance Protocol (quick check and adjustment)

An alternative protocol, complementary to the quality assurance program described above, can be carried out by comparing the current dissolved oxygen reading shown on the 5X00 with those taken by a recently calibrated hand held instrument. For dissolved oxygen, the probe of a handheld DO instrument can be placed in the

stream near the 5X00 probe. If a comparison of the readings from the recently calibrated DO instrument and the 5X00 indicates calibration drift, the 5X00 can be recalibrated. Note - this comparison should only be used to determine if a calibration is necessary once the 5X00 probe has been cleaned of all algae and other debris. If a gross variation is observed between the two instruments (> 1 mg/L), it is likely that maintenance is required on the 5200 DO sensor.

Sensor Care and Maintenance

Periodic DO sensor electrode cleaning and membrane changes are required.

DO Sensor

The DO sensor requires periodic membrane changes and electrode cleaning. For best results, YSI recommends that the electrolyte solution and the membrane cap be changed at least once every 30–90 days (YSI 5420, 5421 and 5422). Refer to the instruction sheet included with the membrane kit for specific instructions on changing a membrane. YSI recommends replacing the sensor cap (ODO 626250) about once per year. The sensor cap should also be replaced if it is cracked or damaged. The instruction sheet shipped with the replacement ODO sensor cap includes the calibration coefficients specific to your sensor cap.

Notes

- Membrane life depends on usage. Membranes will last a long time if installed properly and treated with care. Erratic readings are a result of loose, wrinkled, damaged, or fouled membranes, or from large (more than 1/8" diameter) air bubbles in the electrolyte solution. If erratic readings or evidence of membrane damage occurs, replace the membrane and the electrolyte solution.
- If the membrane is coated with oxygen consuming (e.g. bacteria) or oxygen producing organisms (e.g. algae), erroneous readings may occur.
- Chlorine, sulfur dioxide, nitric oxide, and nitrous oxide can affect readings by behaving like oxygen at the sensor. If you suspect erroneous readings, it may be necessary to determine if these gases are the cause.

YSI 626250 sensor maintenance

The Sensor Cap should be kept clean since some types of fouling may consume oxygen which could affect the dissolved oxygen measurements. To clean the Sensor Cap, gently wipe away any fouling with a lens cleaning tissue that has been moistened with water. Do not use organic solvents to clean the Sensor Cap. Using an organic solvent to clean the Sensor Cap may cause permanent damage to the cap. For example, alcohol will dissolve the outer paint layer and other organic solvents will likely dissolve the dye in the cap.

Before reinstalling the sensor cap, make sure that the cavity is completely dry before proceeding with the installation. If water is found, dry the cavity with lens cleaning tissue. Finally, clean the clear window on the end of the probe with lens cleaning tissue.

YSI 5422 Electrode Maintenance

The gold cathode and silver anode require cleaning about once or twice per year. Perform the following cleaning procedures if, after a DO membrane change, the DO readings are erratic and/or a good calibration can not be performed.

Silver Anode Cleaning

After extended use, a thick layer of AgCl builds up on the silver anode reducing the sensitivity of the sensor. The anode must be cleaned about once or twice per year (depending on use) to remove this layer and restore proper performance.

The cleaning can be chemical and/or mechanical:

Chemical Cleaning: Remove the membrane cap and soak the electrodes in a 14% ammonium hydroxide solution for 2 to 3 minutes, followed by a thorough rinsing with clean water. The anode should then be thoroughly wiped with a wet, lint free cloth to remove the residual layer from the anode.

Mechanical Cleaning: Sand off the dark layer from the silver anode with 400 grit wet/dry sandpaper. Wrap the sandpaper around the anode and twist the sensor. Rinse the anode with clean water after sanding, followed by wiping thoroughly with a wet lint free cloth.

Note - After cleaning, install a new membrane cap with fresh electrolyte and then perform a calibration. Refer to the instruction sheet included with the Membrane kit for instruction on how to replace a membrane.

Turn the instrument on and allow the system to stabilize for at least 30 minutes. If, after several hours, you are still unable to calibrate, contact YSI Customer Service.

Gold Cathode Cleaning

For correct sensor operation, the gold cathode must be textured properly. It can become tarnished or plated with silver after extended use. The gold cathode can be cleaned by using 400 grit wet/dry sand paper. This should be done about once or twice per year.

Using the sand paper provided in the YSI 5238 Probe Reconditioning Kit, wet sand the gold with a twisting motion about 3 times or until all silver deposits are removed and the gold appears to have a matte finish. Rinse the cathode with clean water after sanding, followed by wiping thoroughly with a wet, lint free cloth. If the cathode remains tarnished, contact YSI Customer Service.

Note - After cleaning, install a new membrane cap with fresh electrolyte and then perform a calibration. Refer to the instruction sheet included with the Membrane kit for instruction on how to replace a membrane.

YSI 5420 and 5421 Sensor Maintenance

Perform the following to periodically clean the 5420 and 5421 electrodes.

1. Unscrew the lower body from the upper body.

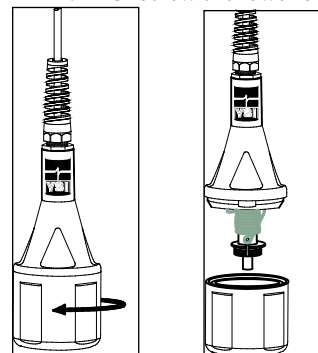

Figure 6.1

2. Safely dispose of the electrolyte that is a special molarity, reagent grade Sodium Chloride solution (salt water).
3. Using the Membrane Tool, unscrew the Membrane Lock in the lower body.

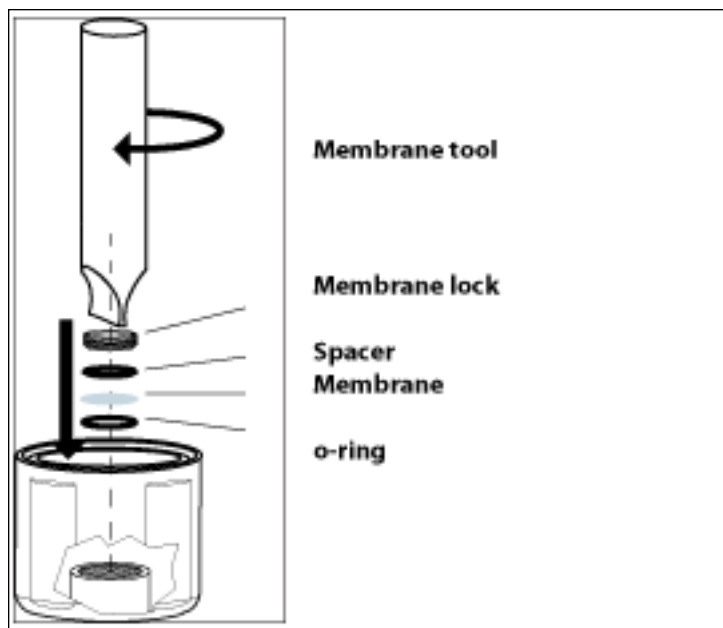

Figure 6.2

4. Remove and dispose of the membrane and its O-Ring as shown above.
5. Using a toothbrush, dish washing powder, and clean water, clean the cathode, anode, and plastic between them. Rinse all components thoroughly.
6. In order, install a new O-Ring into the lower body, then a new membrane, and then the spacer. Using the Membrane Tool, screw the Membrane Lock on top of the spacer as shown in the figure on previous page.
7. Inspect the membrane for wrinkles. Replace if it is wrinkled.
8. Pour some water into the lower body and look for leakage around the membrane. Replace the membrane if there is leakage. If no leakage, dispose of the water.
9. Fill the lower body to its rim with fresh electrolyte as shown.
10. Screw the lower body onto the upper body. Excess electrolyte will leak out at the joint between the sensor's lower and upper body.

Note - Perform a calibration after cleaning and installing a new membrane with fresh electrolyte.

Recommended Cleaning of the 5X00 and Accessories

Clean the 5X00 monitor and accessories as needed. Dampen a cloth with warm water and wipe the outside of the unit. You may use mild detergent with water if necessary. Do not use acid-based, alkali-based, or other organic solvent-based solvents (e.g., acetone, alcohol, etc.).

Storage

Proper storage between periods of usage will not only extend the life of the sensors, but will also ensure that the unit will be ready to use as quickly as possible for your next application.

Short Term Storage

Short term storage is defined as a period of time < 30 days. For short term storage, it is important to keep the sensor in a moist environment without actually immersing it in liquid.

For short term storage, place the 5422 and 626250 probes in the calibration/storage sleeve containing a moist sponge. For the 5420 or 5421 sensor, place the sensor in a cup containing a small amount (~1/8 inch (3 mm)) of water.

Long Term Storage 5420, 5421 and 5422

Long term storage is defined as a period of time > 30 days.

The DO sensor should be stored dry with a dry membrane installed to protect it from dust, dirt, and grit.

1. Remove the used membrane.
2. Rinse the DO sensor with distilled or deionized water.
3. Dry the DO sensor and install a new, dry membrane cap.

Long Term Storage 626250

Long term storage is defined as a period of time > 30 days.

The 626250 sensor MUST BE STORED IN A MOIST ENVIRONMENT, i.e., either in water or in water-saturated air. If the sensor cap is allowed to dry out by exposure to ambient air, it is likely to drift slightly when next used.

1. Moisten the sponge in the red protective plastic cap that was provided with the probe and place it over the sensor with the sensor cap installed.
2. Inspect the sponge every 30 days to make sure it is still moist. If you no longer have the red protective cap, then moisten the sponge in the calibration/transport sleeve and place this over the probe.
3. Alternatively, you can place the probe with sensor cap directly in a beaker or other container of water, making sure that the water does not evaporate over time.

Sensor Replacement

The 5422 DO sensor is user replaceable. Refer to the instruction sheet provided with the replacement sensor for detailed instructions.

Charging DC batteries

The 5X00 does not charge batteries. Quality assurance maintenance procedures should be established if batteries are to be fully powered when used as back-up power source

AquaManager Database Maintenance

See *AquaManager Database Maintenance - 204* and *AquaManager online Help* for additional information.

Replacement Parts & Accessories

See www.YSI.com for replacement part and accessory information and Appendix 5 of this manual - 252.

Appendices

- Appendix 1 - Unpacking and Inspection
- Appendix 2 - Troubleshooting
- Appendix 3 - Menu Maps
- Appendix 4 - Declaration of Conformity-
- Appendix 5 - Parts and Accessories
- Appendix 6 - SMS Messaging
- Appendix 7 - Alpha "A" Curve
- Appendix 8 - Warranty
- Appendix 9 - Contact Us
- Appendix 10 - Recycling

Appendix 1 - Unpacking and Inspection

Inspect the outside of the shipping carton for damage. If damage is detected, contact the carrier immediately. Remove the 5X00 from the shipping container. Be careful not to discard any parts or supplies. Confirm that all items on the packing list are present. Inspect all assemblies and components for damage. Save the original packing carton. Carriers typically require proof of damage due to mishandling.

The following components are included with the purchase of the 5X00 instrument:

5X00 instrument
 006515 Flange Mounting Kit
 006506 Desiccant Kit
 605877 Instruction Manual
 605230 Compression Plugs, 2 each
 605229 Compression Plugs, 2 each
 605804 Compression Plugs, 4 each
 605898 Compression Plugs, 3 each
 655384 Dual Male RJ-45 Cable Assembly
 655383 Adapter, DB-9 to RJ-45
 605880 AC Power Cord, 155 VAC U.S. Plug (AC version only)
 605944UL Pluggable Socket Connector for AC Power, 3 pole (AC version only)
 506939UL Pluggable Socket Connector for 12 VDC Power, 2 pole
 605941UL Pluggable Socket Connector for RS-485, 5 pole
 605943UL Pluggable Socket Connector for relays, 12 pole, 2 each
 605940UL Pluggable Socket Connector for Auxiliary Inputs, 3 Pole
 605942UL Pluggable Socket Connector for DO and AUX inputs, 8 Pole, 2 each

If any parts are damaged or missing, contact YSI or your YSI representative immediately.

Appendix 2 - Troubleshooting

Sensor Troubleshooting

- When troubleshooting sensors, disable the control/alarm relays.
- Verify 5X00 wiring and configuration.

Issue	possible cause	possible solution
inaccurate or fluctuating sensor values	improper placement of probe assembly	See <i>Location Considerations - Step 2 Locate and Install Probe Assembly</i> - 34..
	fouled membrane or sensor cap; damaged membrane or sensor cap	visual inspection of the probe assembly required. Clean membrane or sensor cap.
	improper placement of 5X00	See <i>Location considerations - Step 1 Install 5X00</i> - 27.
	bad sensor bad DO membrane	recalibrate, change membrane, clean sensor, test sensor outside system stream in solution of known value, replace sensor
	sensor out of calibration	See <i>Calibration</i> - 81..
	DO elevation configuration incorrect	Correct DO elevation at Menus → System → Sensor Setup→DO→Elevation menu
	DO values are affected by temperature. If DO values are incorrect, verify that the temperature source is accurate and reporting correct values or that the user defined temperature value is correct for the DO sensor location. If the temperature sensor is reporting incorrect values, the DO mg/L values are not reliable.	See <i>DO and temperature</i> - 174.
DO-galvanic or polarographic inaccurate values	DO sensor wires are terminated incorrectly	see <i>Wire DO sensors</i> -49..

Sensor Troubleshooting continued

Issue	possible cause	possible solution
	probe assembly ground wire or temp sensor wires (if not in use) are causing interference)	cut back unused wires to cable sheathing to avoid shorting.
“over/under” sensor readings	bad sensor bad membrane	clean sensor, replace membrane, calibrate sensor, test sensor outside system stream in solution of known value, replace sensor
no sensor value on screen	sensor not enabled	See <i>Sensor Setup</i> - 150..
	display setting configuration set for multiple Run Screens	See <i>Display Setting</i> - 123.
“check probe” message at sensor calibration	improper placement of probe assembly, incorrect sensor wire connection(s), improper placement of 5X00, bad sensor, and/or bad membrane	See <i>Location Considerations Probe Assembly</i> - 34 See <i>Wire sensors</i> - 49. See <i>Location Considerations 5X00</i> - 27. clean sensor, calibrate, test sensor outside system stream in solution of known value, replace membrane and/or replace sensor if necessary
Analog aux value is overlapping to adjoining sensor window	1X1 & 2X2 display format setting cannot display values over 7 digits in aux sensor window	Adjust aux display format to lower resolution i.e. from 0.00 format to 0 format. See also <i>Notes: Display Screen Limitations</i> - 124..

Relay (Outputs) Troubleshooting

- Disable control, alarm, and timer relays when troubleshooting relay outputs.
- Verify 5X00 wiring and configuration.

Issue	possible cause	possible solution
relay does not energize	incorrect sensor configuration	See <i>Sensor Set up</i> - 150. relay not enabled
	incorrect timer configuration	See <i>Timers</i> - 180..
	30 second delay at power up and/or sensor configuration change	30 seconds delay - see 248..
	peripheral device is wired incorrectly	See <i>Wire Relays</i> - 54. The device is incorrectly wired to NO or NC terminal strip ports..
	relays are not enabled for control/alarm/timer system	Verify menu configuration (relay enable) for control/alarm/timer system. See sensor system set up - 150. See timer system enable - 180.
temp (high) does not de-energize when set point value is read	sensor is configured for timed control	Verify setpoint and control configuration values - 157.

Email Alarm Troubleshooting

Issue	possible cause	possible solution
no 5X00 email alarm message received	5X00 display is not at Run Screen - all alarming is suspended when in menus	exit to run screen to reset alarm email alarm system
	Serial to ethernet device did not initialize properly. Check the event log for “unable to initialize error”.	disconnect power to 5X00, verify installation of serial to ethernet device on lower board and repower
	faulty ethernet serial to ethernet device	replace serial to ethernet device

Email Alarm Troubleshooting continued

Issue	possible cause	possible solution
	Are the alarms enabled in sensor menu? Is the general alarm enabled?	see <i>Sensor Setup Alarms Values</i> - Set point control mode - 156 and PID/PDW control mode - 163. see <i>General Alarm</i> - 131..
no email alarm received for slave alarm condition	Are slaves enabled on network?	enable slaves at Menus → System → Communications → Network → Master
no test email alarm message received	exit to run screen from communication menu not done	exit to run screen to process test email request

Network Troubleshooting

Issue	possible cause	possible solution
no communication to networked unit(s)	Are master/slave menus properly configured?	See <i>Networking</i> - 97..
	Is termination relay enabled in 1st & last 5X00 on network?	See <i>Termination Relay</i> - 99..
	Is proper communication method configured and wired properly?	See <i>Networking</i> - 97. See <i>Wire Communication Equipment</i> - 66..
	Are slaves enabled and recognized at master?	enable slaves at Menus → System → Communications → Network → Master
	more than one device is configured as a master	verify configuration at Menus → System → Communications → Network → Master/Slave menus on all nodes.
slow network performance	nicked wires; improper wiring	Verify network wiring - See <i>Wire Network</i> - 60.

Network Troubleshooting continued

5X00 Systems Troubleshooting

Issue	possible cause	possible solution
time and date lost at power up	bad lithium battery	replace lithium battery
no events in event log	event logging not enabled	See <i>Event Logging</i> - 120..
no data in data log	data log interval time has not passed	See <i>Data Logging</i> - 118.
cannot view specific data log records at 5X00	Data log record has older date and time-stamp than the 25 most current data log records available at 5X00 sensor log.	See <i>Data Logging</i> - 118.

Firmware Updater Troubleshooting

Issue	possible cause	possible solution
Device “timed out” error	incorrect configuration in 5X00 communication menu	See <i>Device Timed Out error</i> - 130.
	incorrect wiring of RS232 connection	See <i>Device Timed Out error</i> - 130.
5X00 does not go into downloader mode when “program device” is selected at Firmware Updater		Manually put 5X00 in downloader and retry firmware updater upload. Menus → System → Downloader
		See <i>Force downloader</i> - 130..
unit does not upload new code at downloader	unit is not in downloader mode	See <i>Downloader</i> - 126..
	RS232 connection is incorrect	See <i>Wire Communications - RS232</i> - 66..

Feed Timer Troubleshooting

Issue	Understanding how the 5X00 calculates sensor reduction time
Sensor reduction % is not accurate based on display sensor value(s).	The 5X00 displays temperature sensor values to the 10ths and DO values to 100ths. In reality the 5X00 temperature and DO sensor system values are stored at a much greater resolution (out to 64 bits). It is the stored values, not the displayed values, that are used to calculate the feed timer sensor reduction.

AquaManager Troubleshooting

Refer to AquaManager online Help for all AquaManager operation and troubleshooting information.

Appendix 3 - Menu Maps

This Appendix contains the menu structure for 5X00 firmware. The menu maps contain all menus, submenus, factory defaults, and user selectable ranges of the 5X00 firmware. Menu maps are presented in hierarchal format. All menus are accessed by pressing **Menu** at the Run Screen. Menu maps are provided in the following order:

1. Calibration menu
2. System menu
3. Sensor Setup menu
4. Timers menu

The example below shows how to navigate the menu maps in the 5X00. First find the menu you want to configure. For example, IP address for the serial to ethernet device. Then follow the path highlighted at the top of menu. Continue to follow the menu path under and to the right of the menu heading to access submenu;

Run Screen → Menu → System Menu → Communication

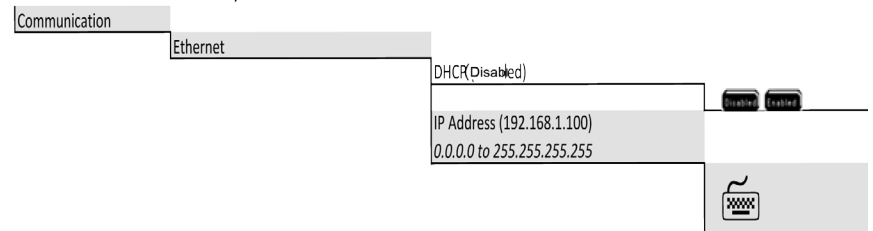

Key strokes to enter IP address as depicted above.





1. From the Run Screen, press the softkey below **Menu** label;
2. **↵** to enter System menu.;
3. Scroll down (if necessary) to highlight communication menu;
4. **↵** to enter communication menu;
5. Scroll (if necessary) to highlight ethernet menu;
6. **↵** to enter ethernet menu;
7. Scroll down (if necessary) to highlight IP address menu;
8. **↵** to enter IP address menu; - numeric keypad is displayed;
9. Configure the IP address using numeric keypad;
10. **Save** after entering IP address;
11. **Exit Menu** to save configuration and return to run screen.

Menu Map Key

The following conventions are used in menu maps:

- Factory defaults are contained in (). If blank, no default value is loaded for this menu. In certain menus, the user configuration will appear in () once the menu is configured.
- System range (if applicable) is in *italics*. “*” displayed after the range indicates that the range is based on other system configuration i.e. set point submenus.
- (Not Available) indicates hardware is not installed or menu is not applicable to system configuration.

The following graphics are used in menu maps:

-  - Input is required at numeric or alpha/numeric keypad.
-  - display of softkey indicates selection of softkey is required.
-  - Make a selection from a pull down menu.
-  - Use three front panel key to proceed; (only used at adjust contrast menu).

The menu map on the following page depicts how the menu map conventions and graphics are used for configuring the DO alarm low value and enabling the DO system alarms. (complete DO menu is not shown in example)

MENU MAP EXAMPLE

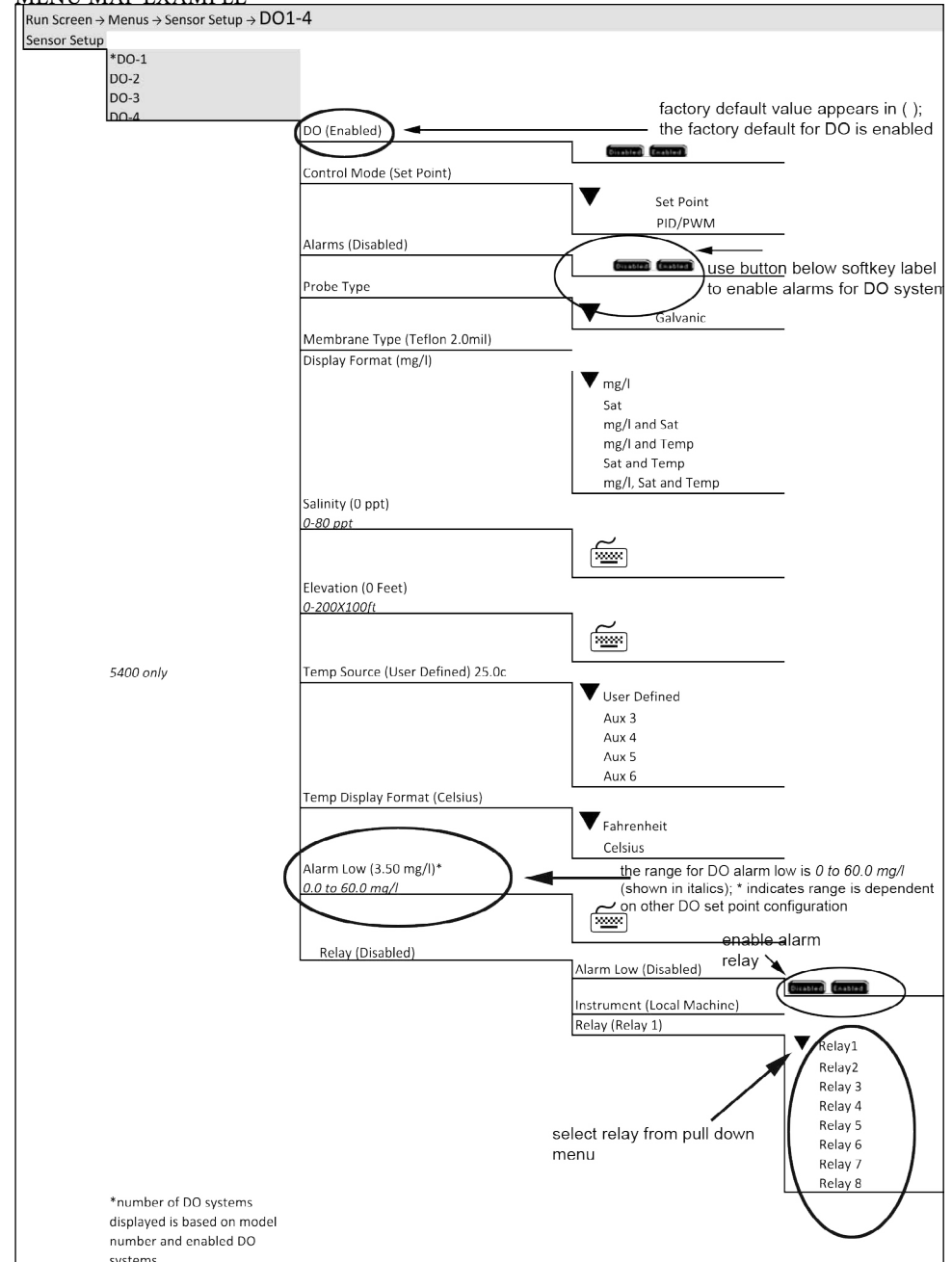

Menu Maps

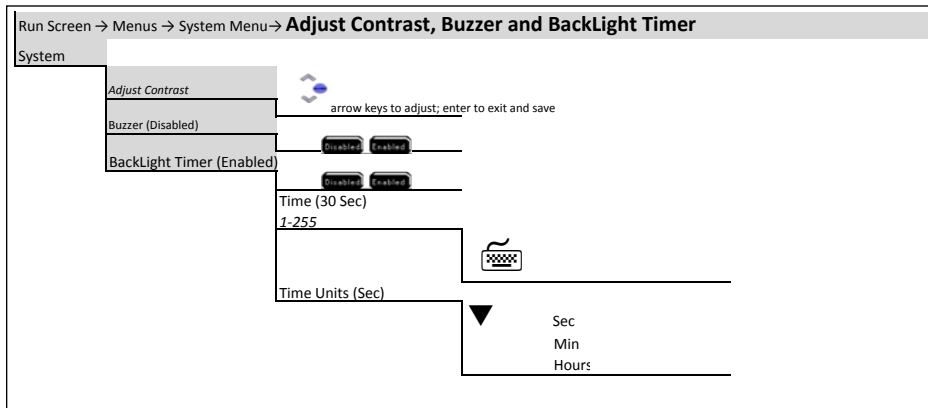
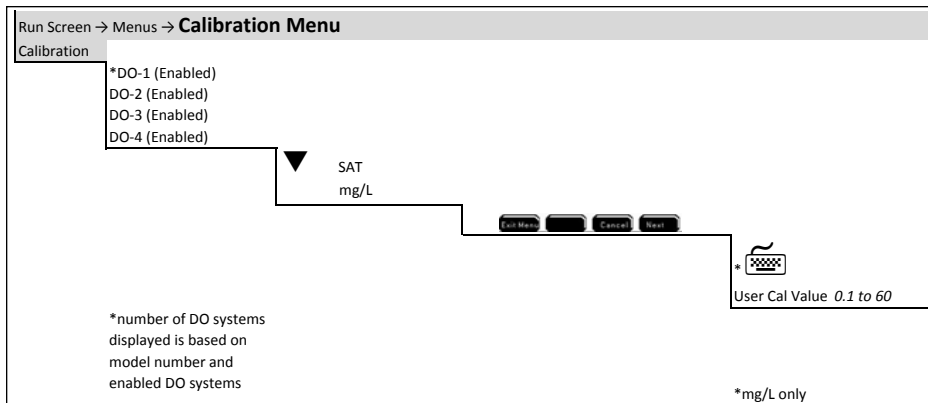

Menu Maps

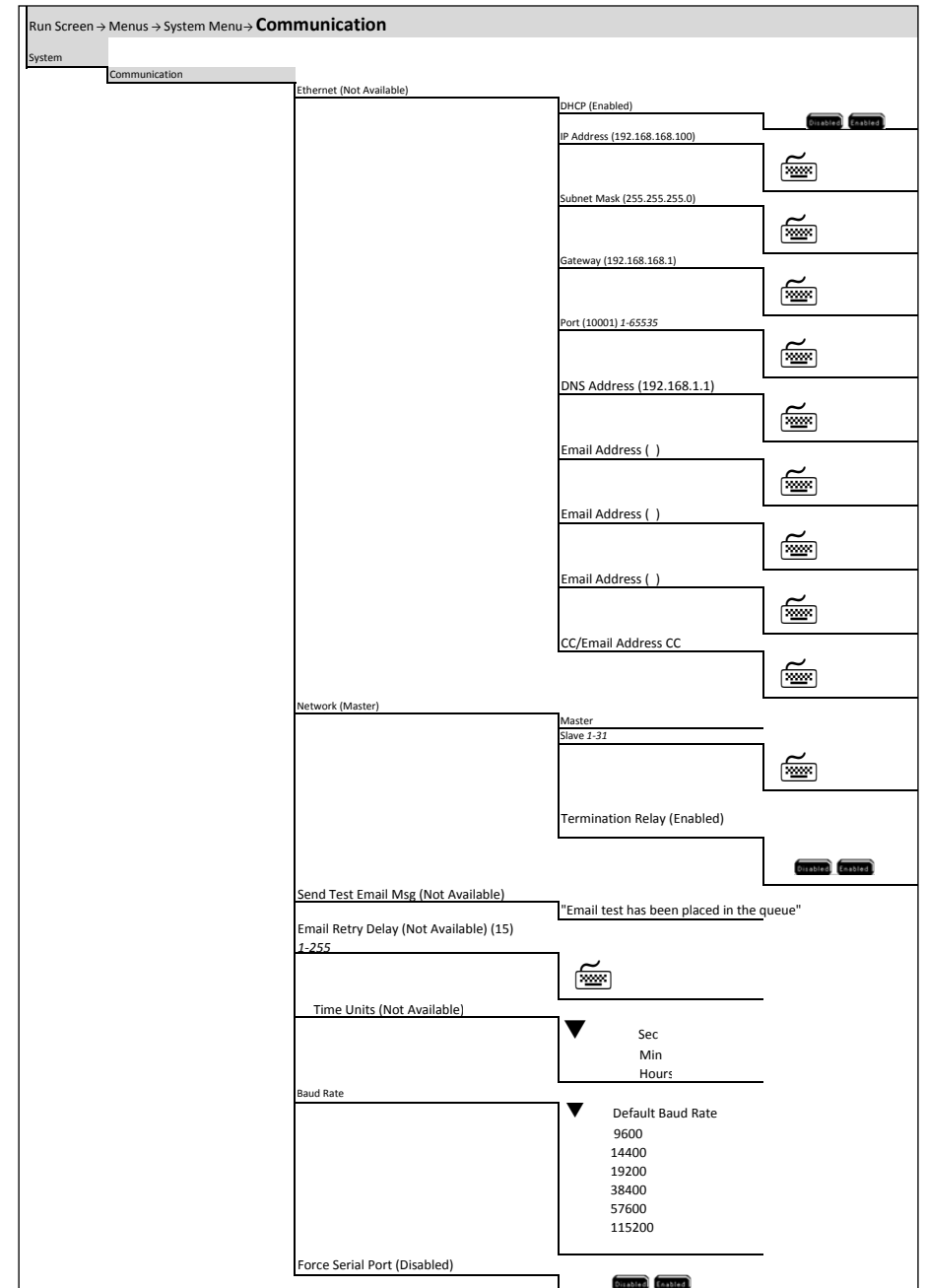

Menu Maps

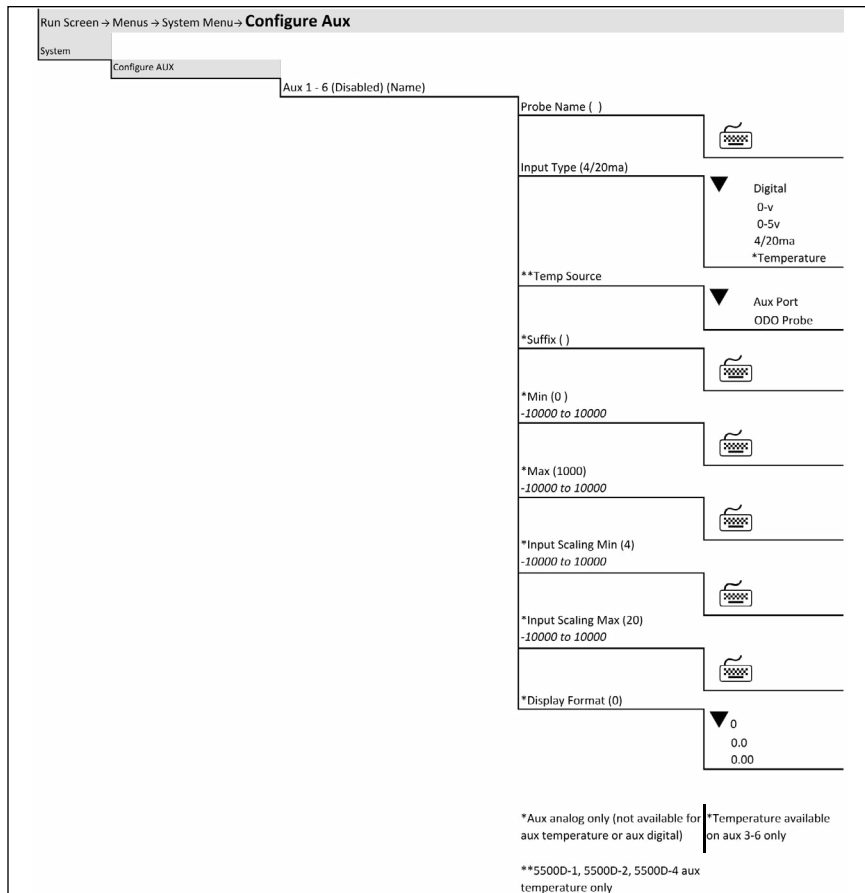

Menu Maps

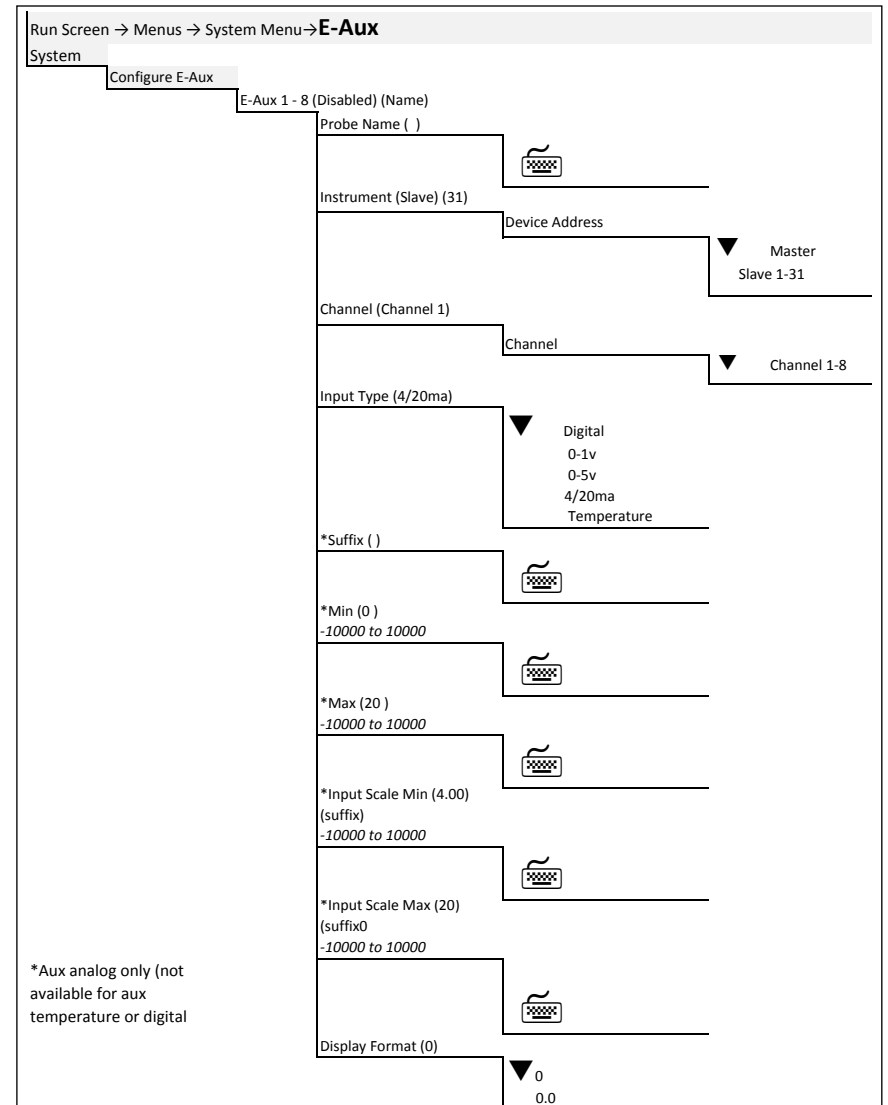

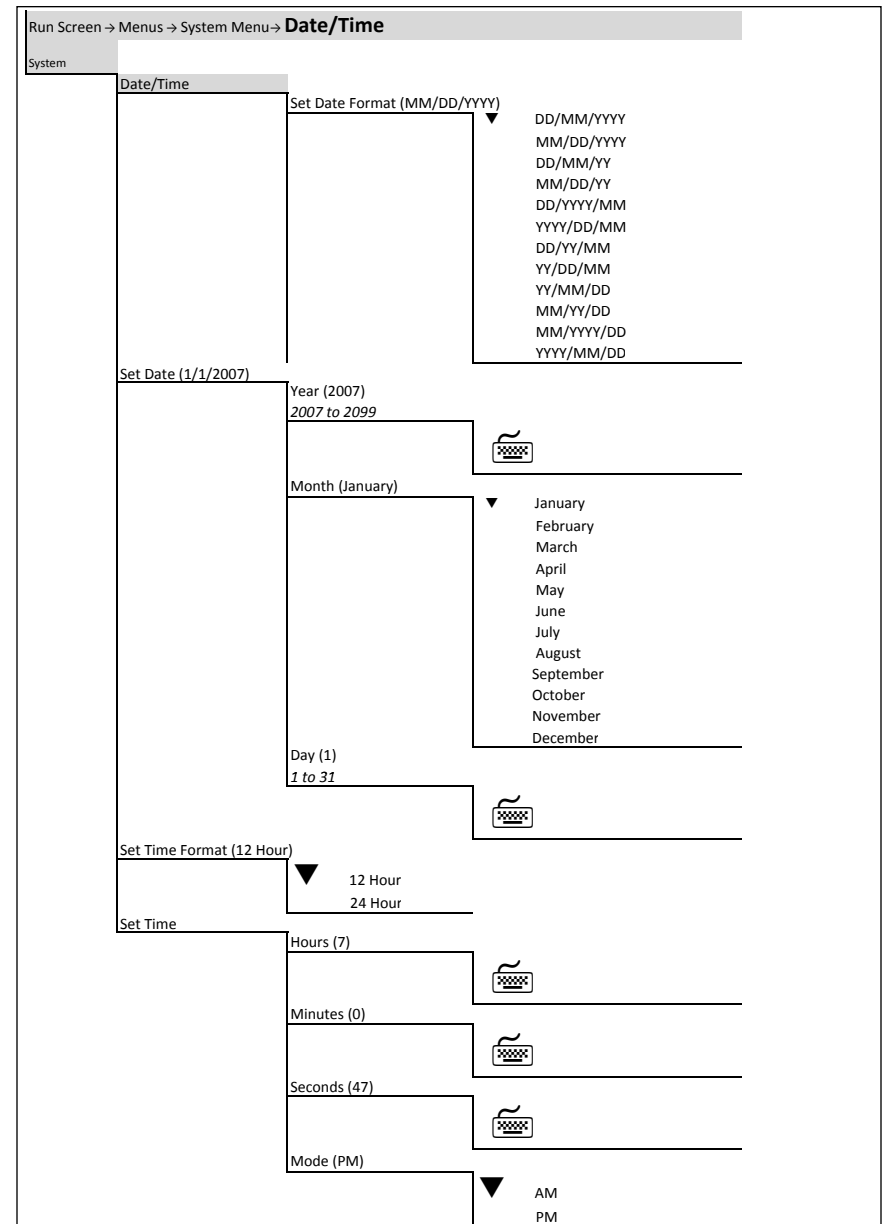
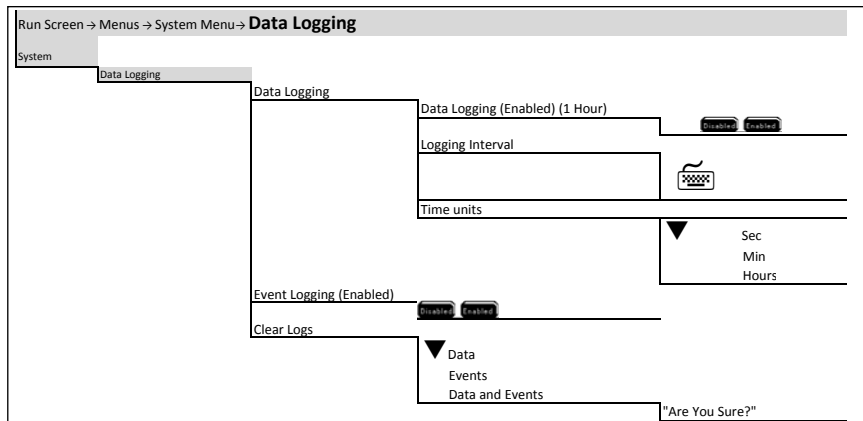

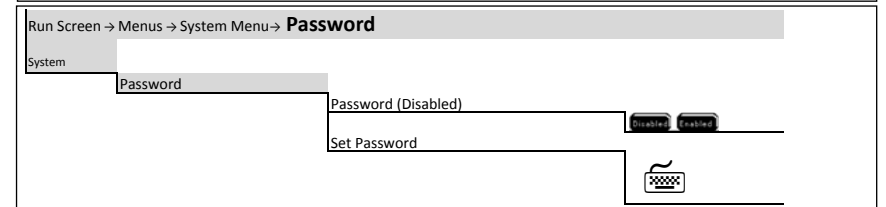
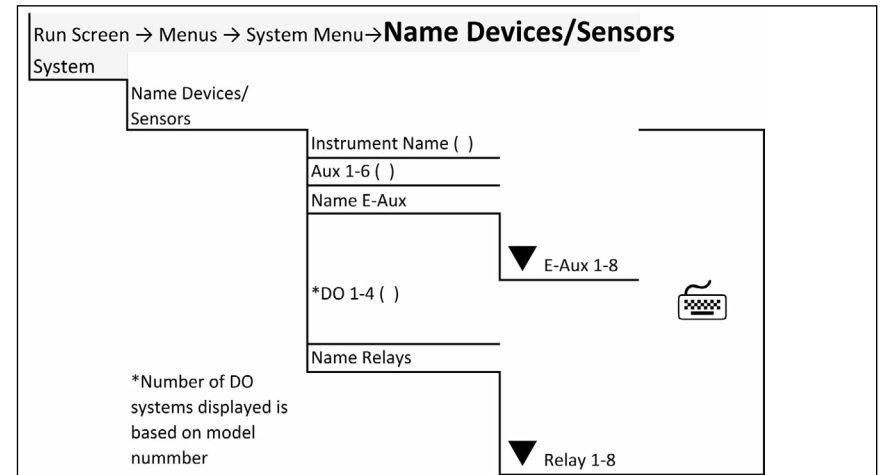
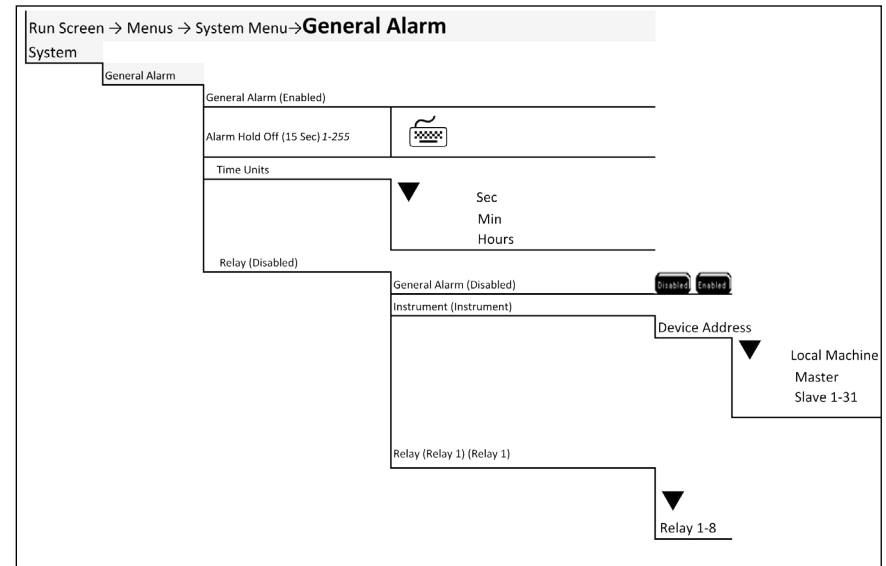
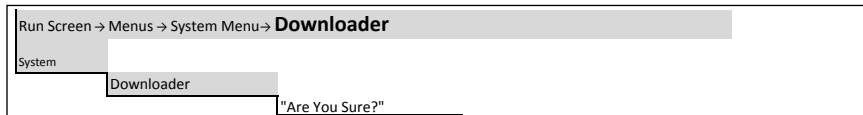
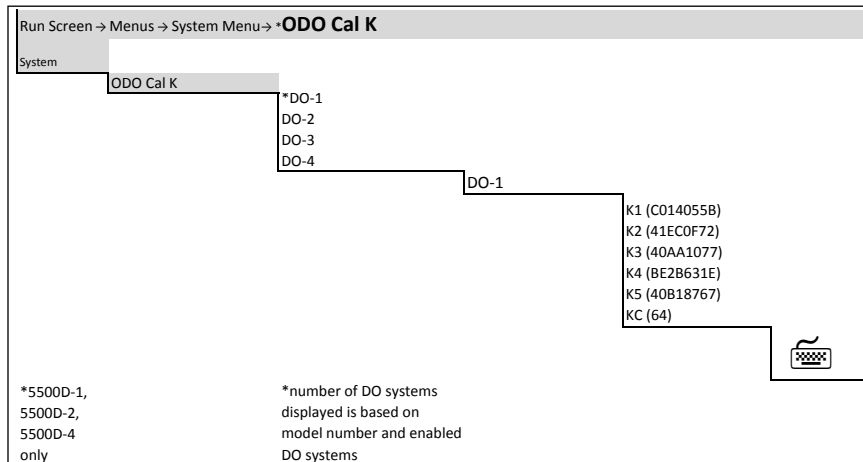
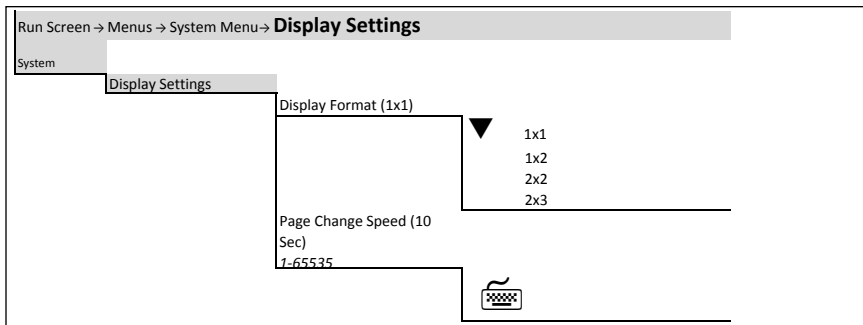

Menu Maps

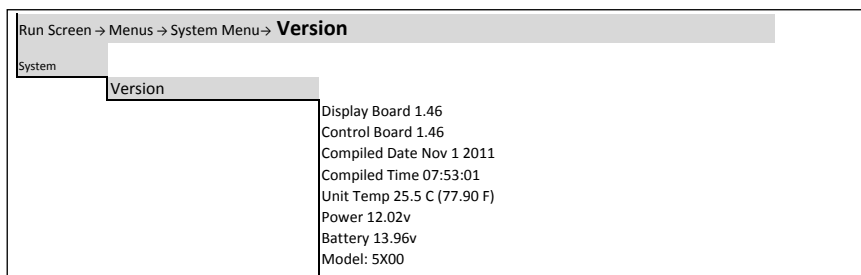
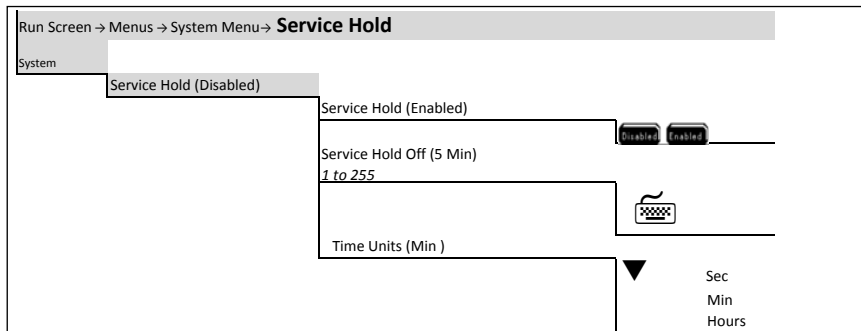
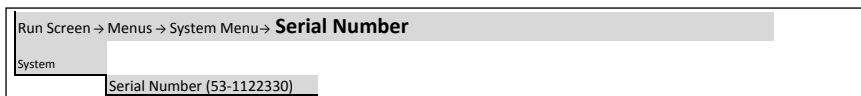
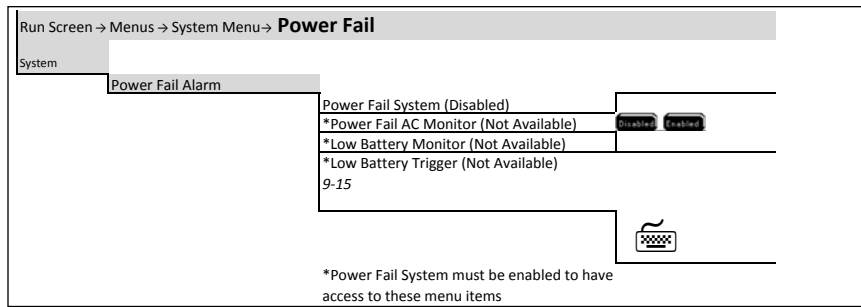

Menu Maps

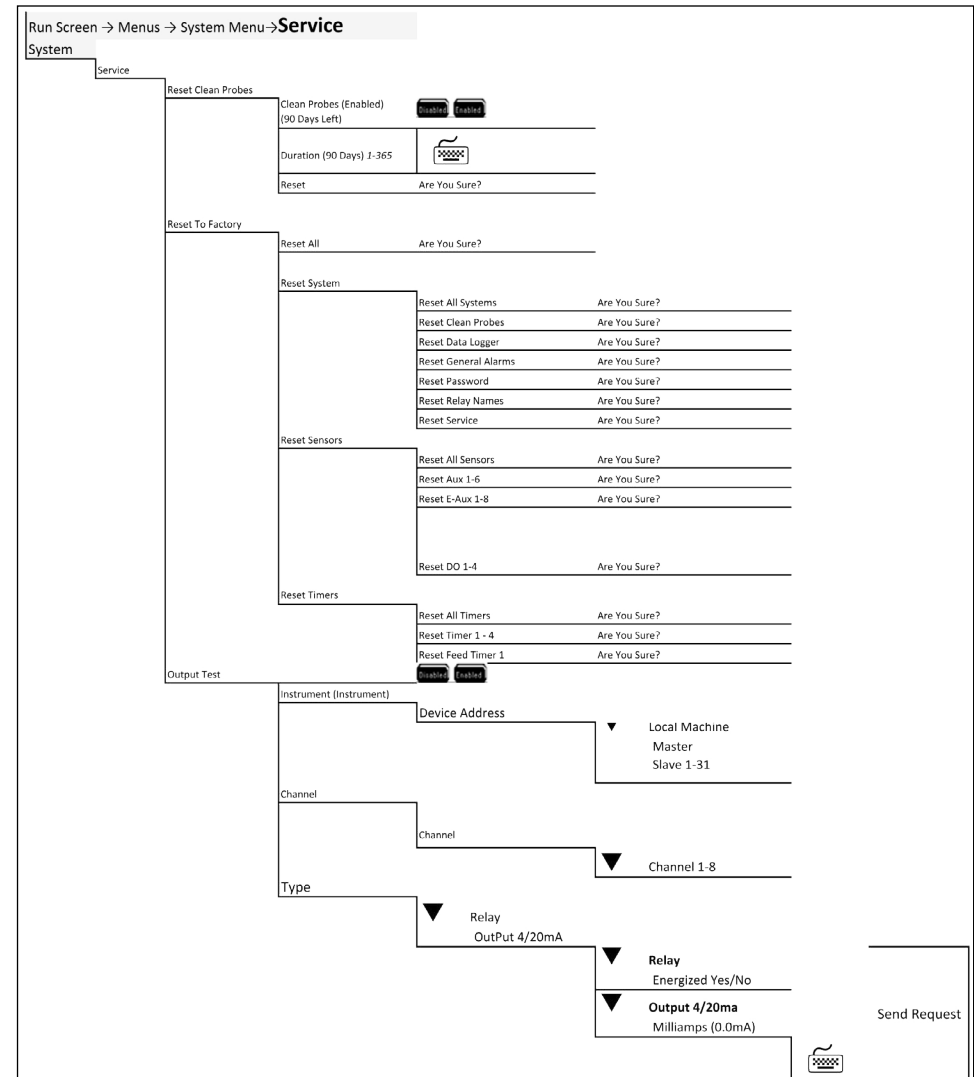

Menu Maps

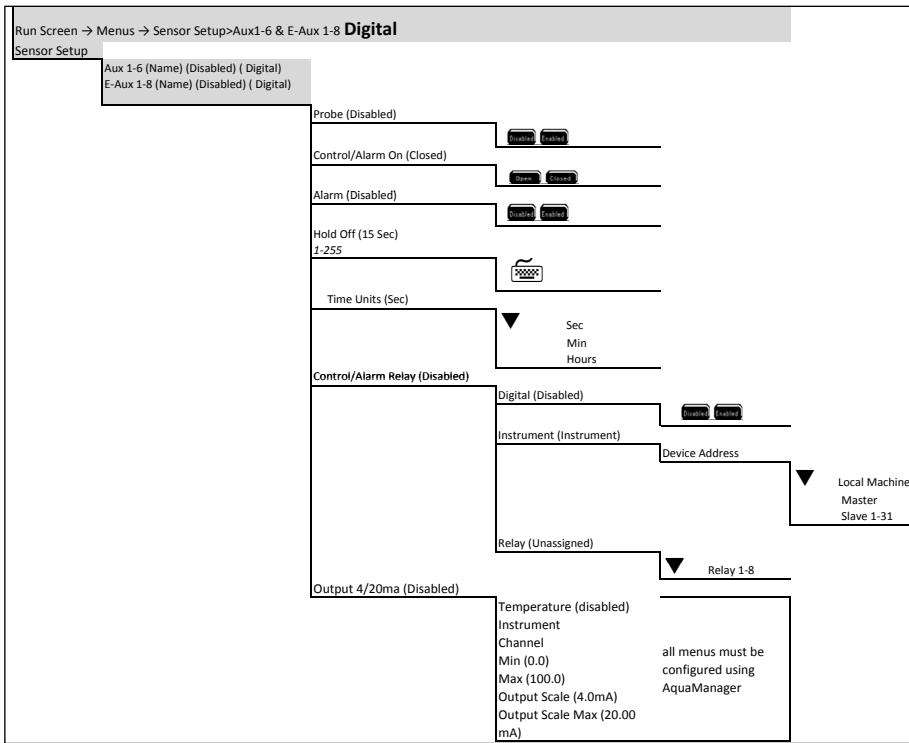

Menu Maps

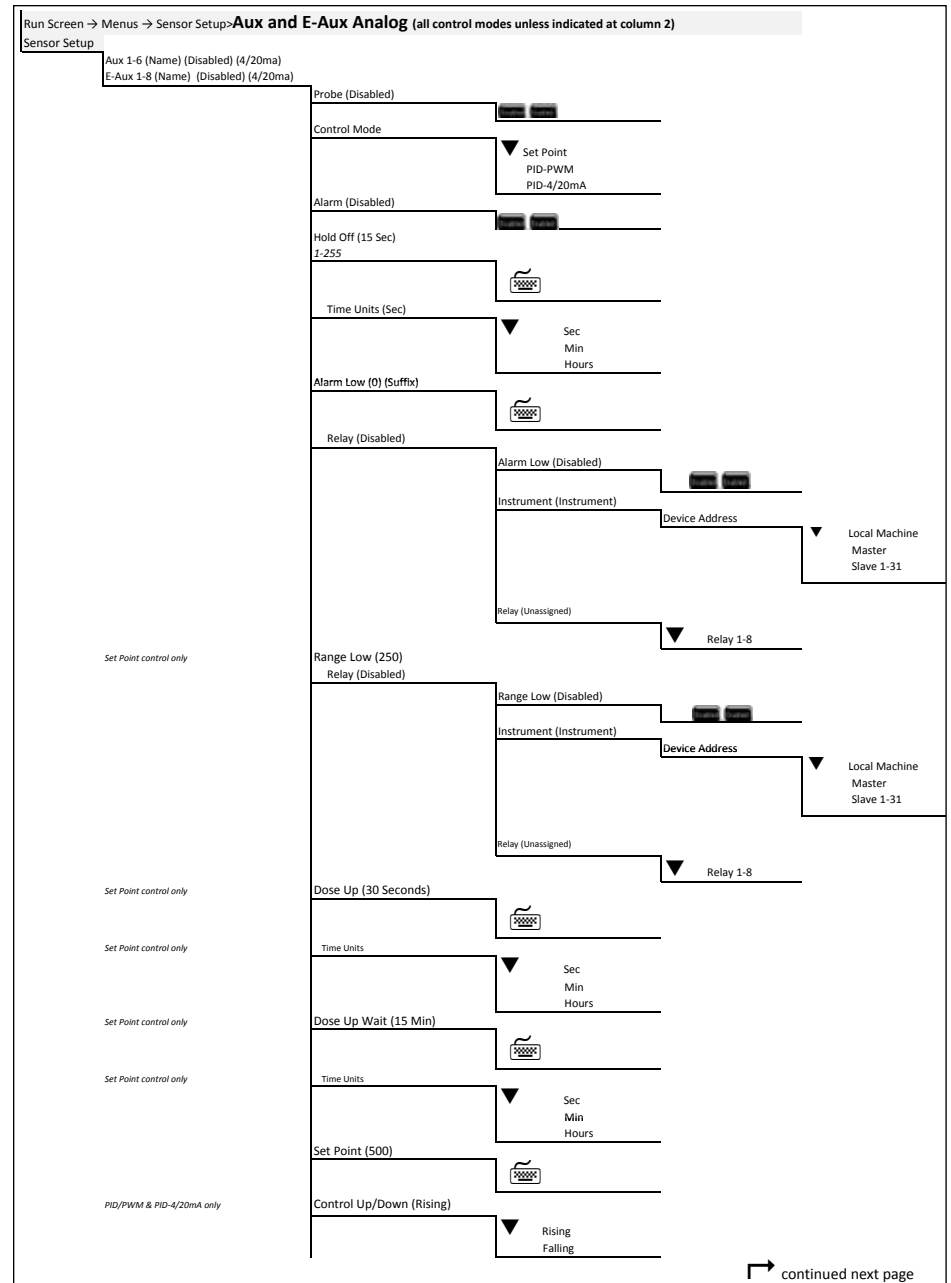

Menu Maps

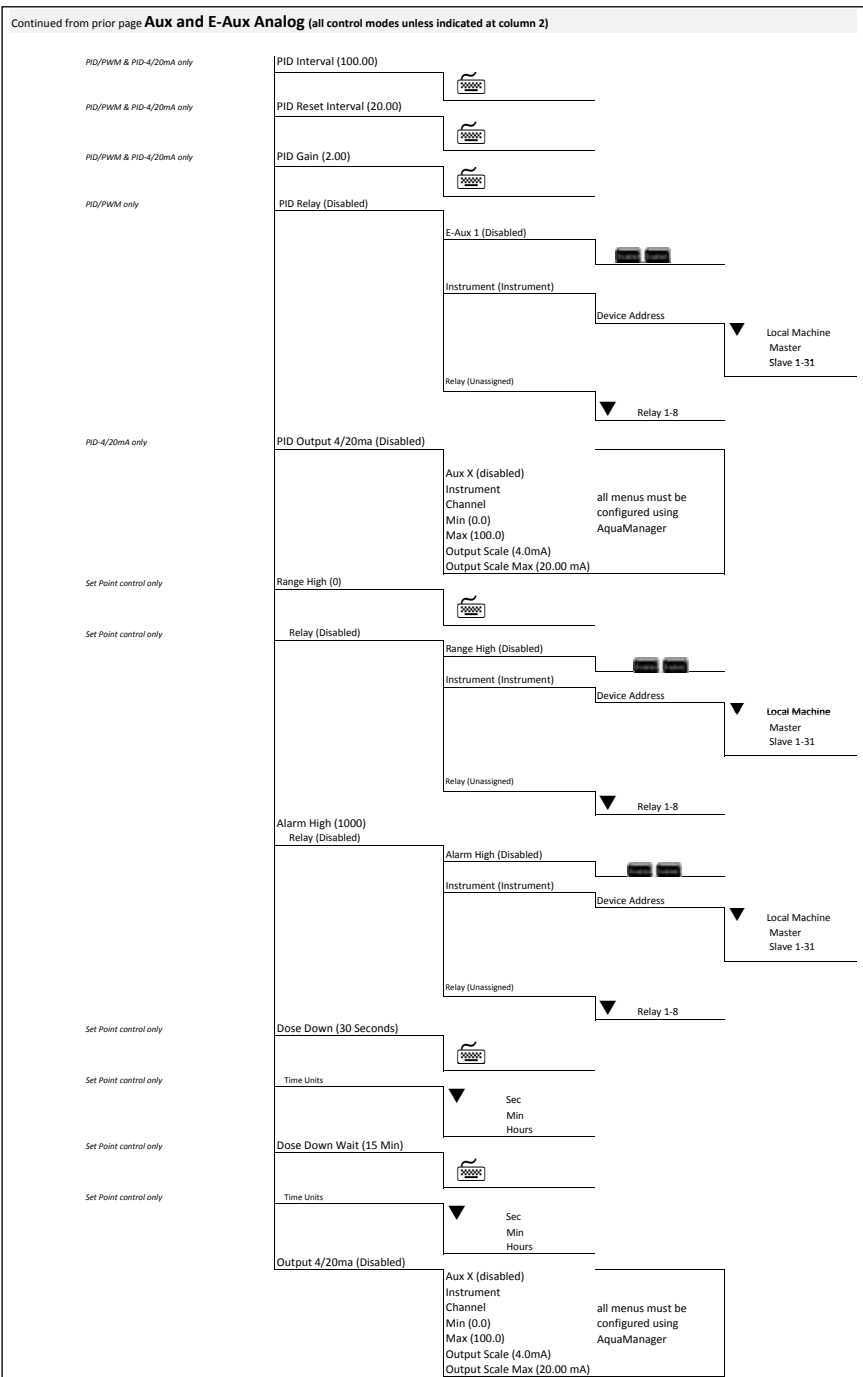

Menu Maps

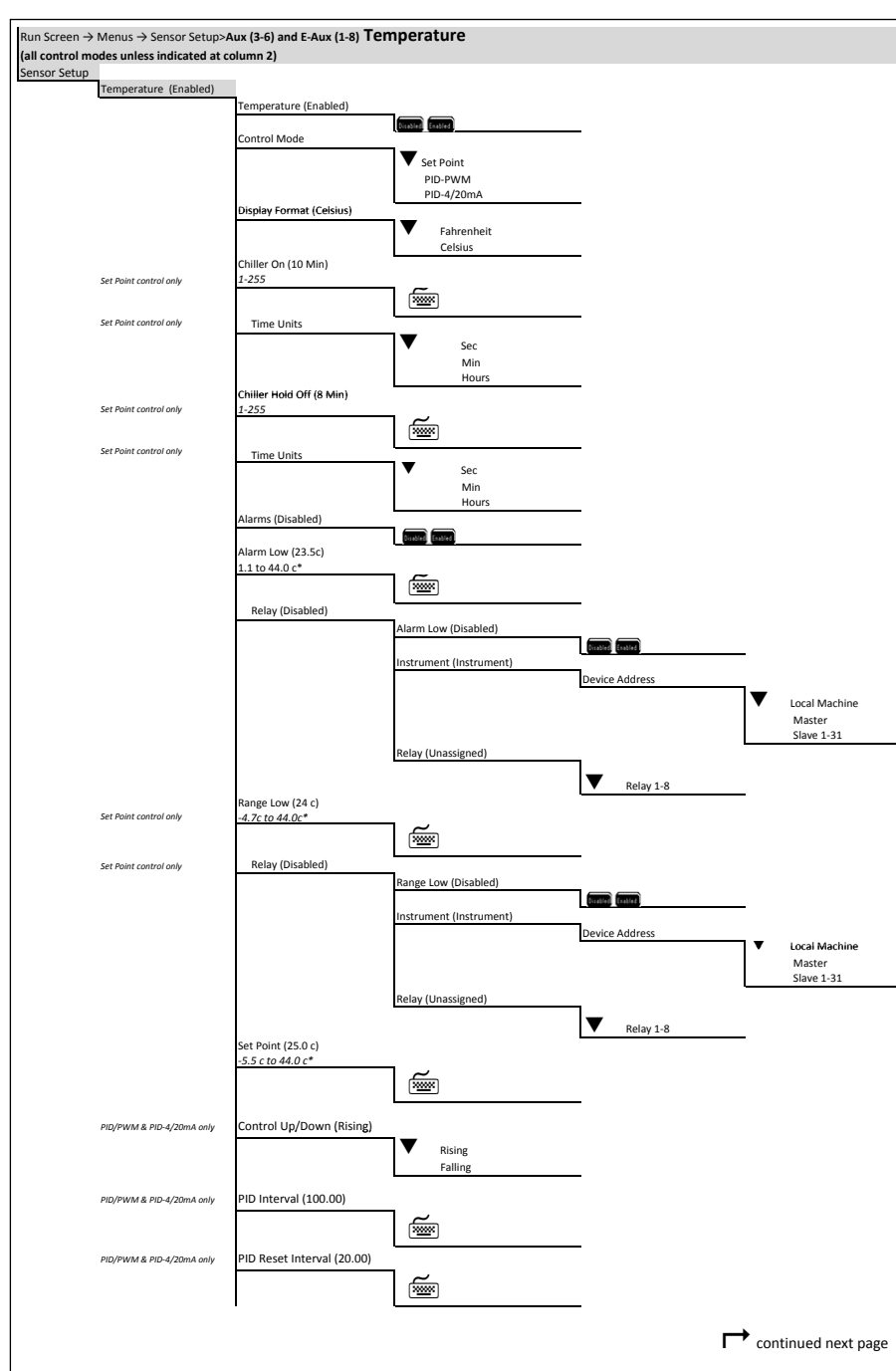

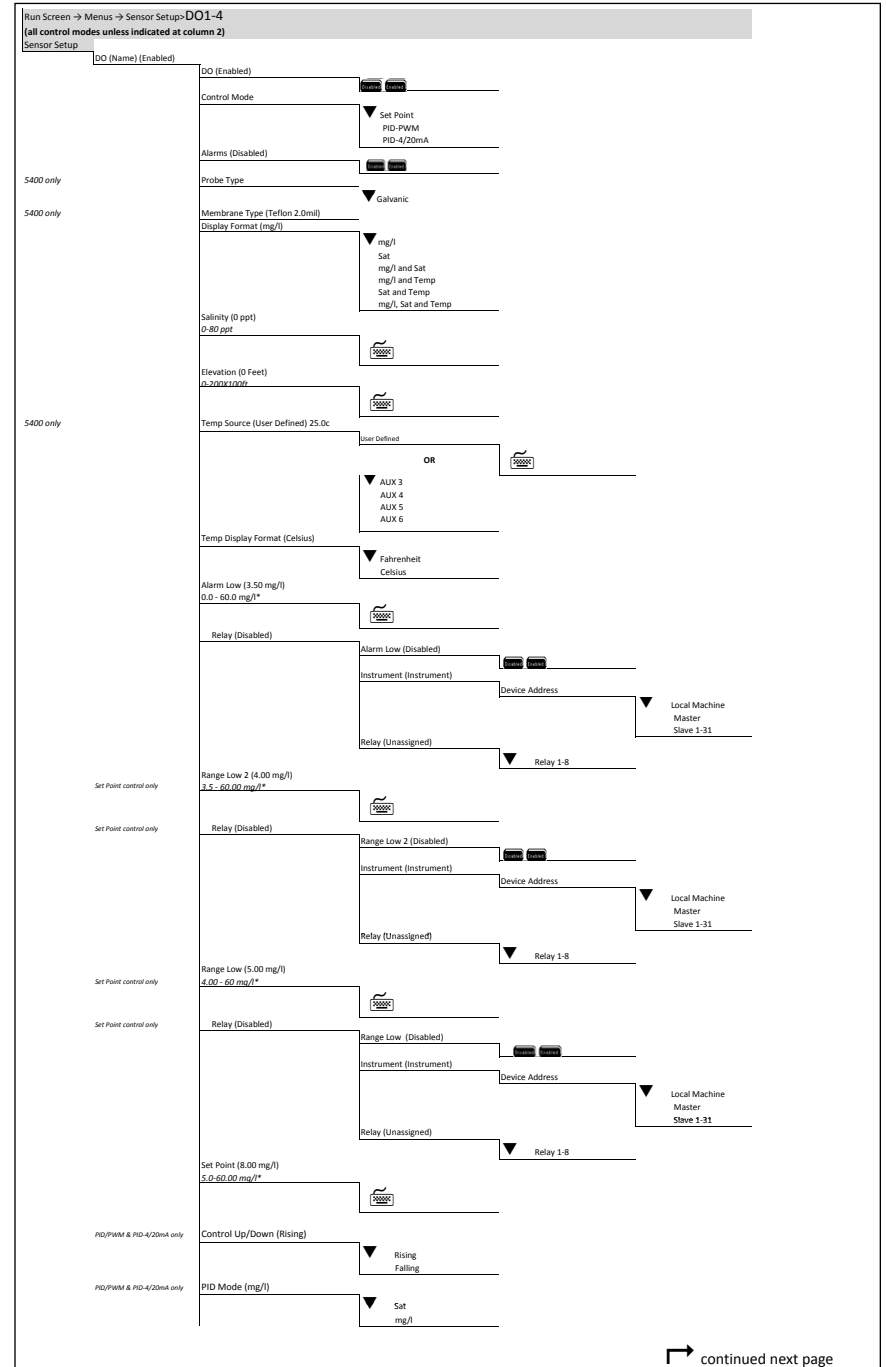
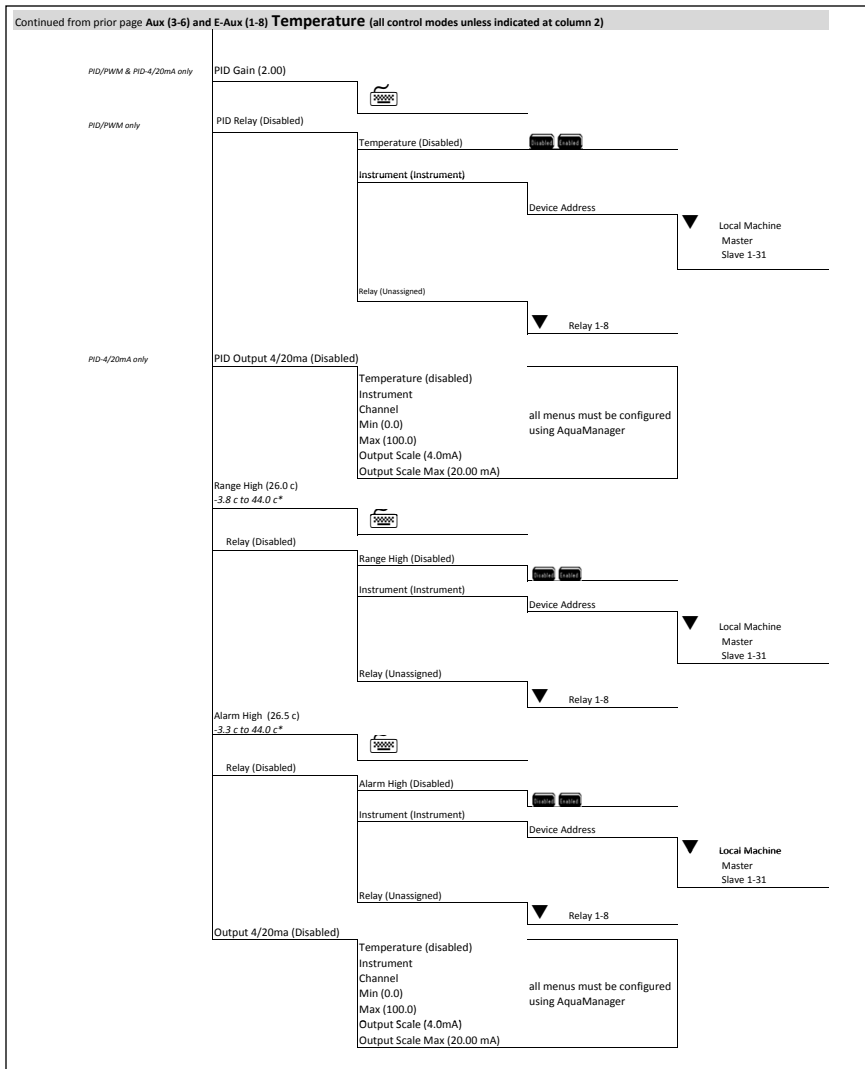

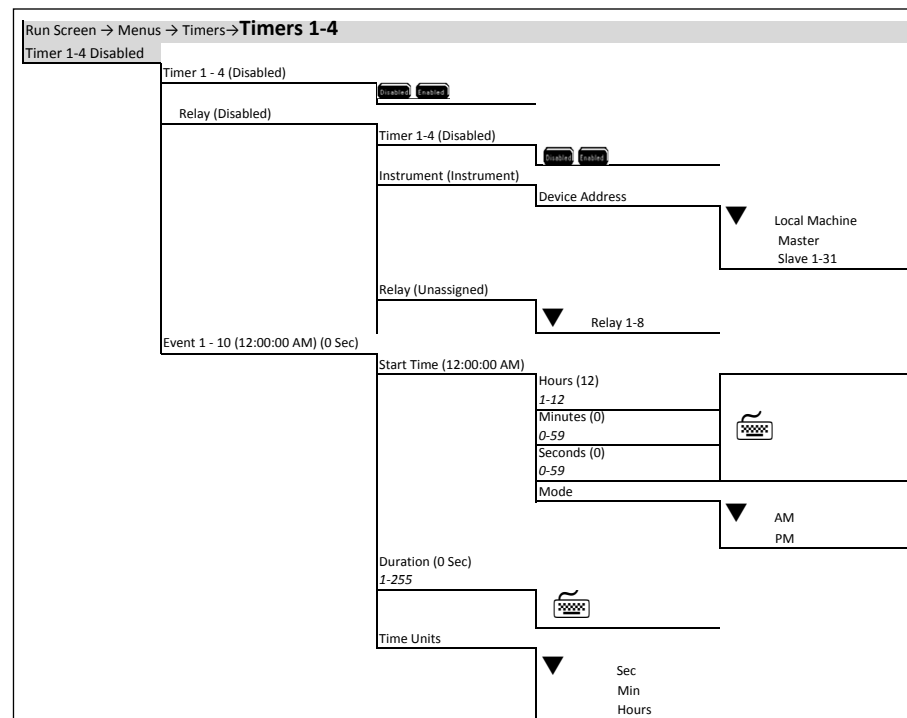
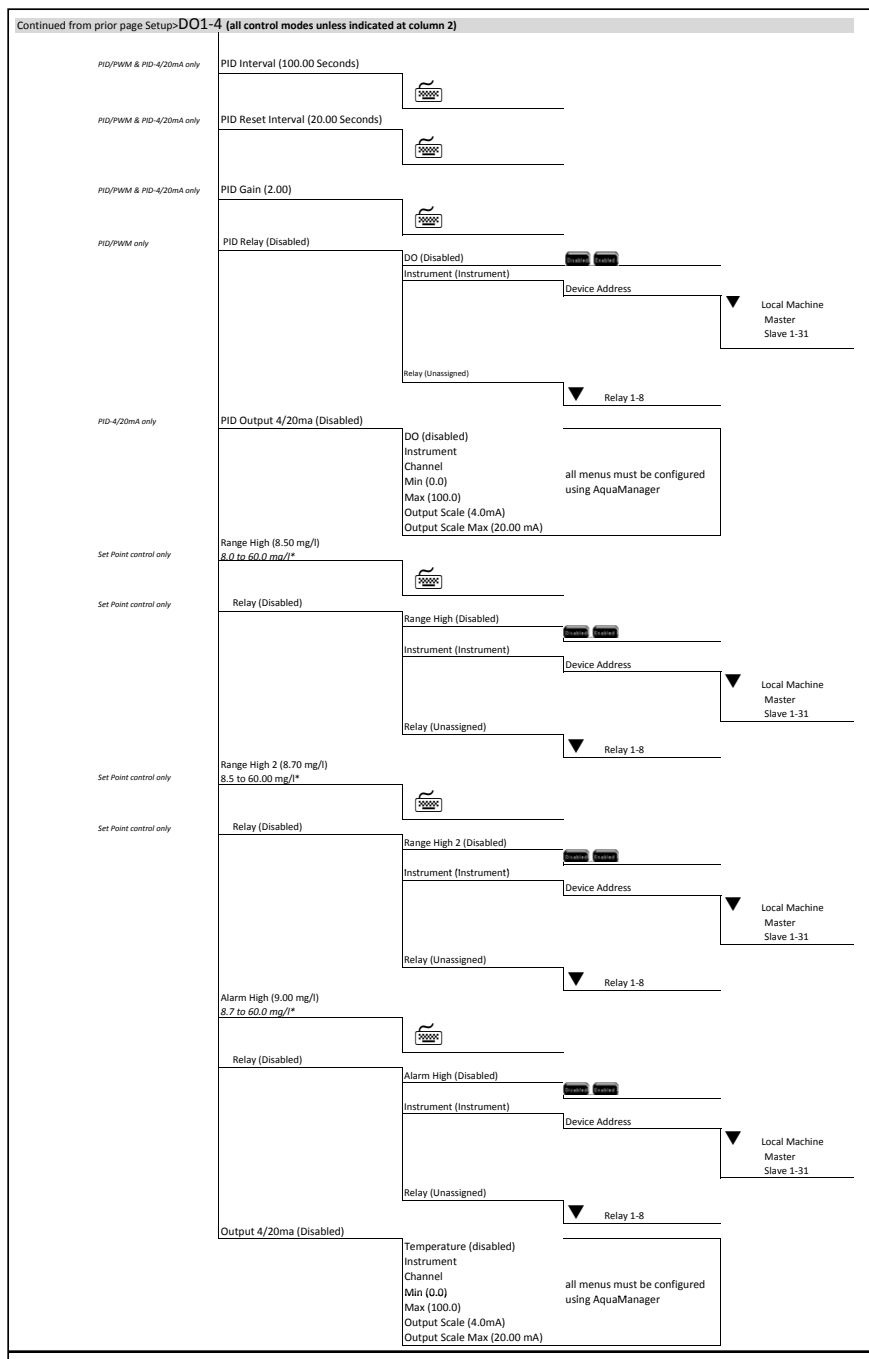

Menu Maps

Run Screen → Menus → Timers → FeedSmart **Timer 1-4**
 FeedSmart™ Timer 1-4 (Disabled)

Feed Timer (Disabled)

FCR (Disabled)

Biomass (0 oz)
1 to 100000

Feed % Biomass (0.00%)
0.01-99.90%

Daily Weight (0 oz)
1 to 100000

FCR Factor (0.03%)
0.01 to 100.00

Feeder

Feed Mode
 Timed
 Continuous

Daily Weight (0 oz)
1 to 100000

Daily Feedings (3) 1-255

Start Date (01/01/2007)
 Year (2007)
2007-2099

Month (January)
Jan-Dec

Day (1)
1-31

Start Time (12:00:00 AM)
 Hours (12)
1-12
 Minutes (0)
1-59
 Seconds (0)
1-59
 Mode (AM)
AM
PM

End Date (01/01/2007)
 Year (2007)
2007-2099

Month (January)
Jan-Dec

Day (1)
1-31

→ continued next page

Menu Maps

Continued from prior page FeedSmart **Timer 1-4**

End Time (12:00:00 AM)
 Hours (12)
1-12
 Minutes (0)
1-59
 Seconds (0)
1-59
 Mode (AM)
AM
PM

Sun-Sat (Disabled)

Sensors(Disabled)

Sensors (Disabled)

DO Low (0.00 mg/l)
0 to 60.00

DO High (0.00 mg/l)
0 to 60.00

DO Change (0.01%)
0.00 to 9.9%

Temp Low (0.0 c)
1c to 44.0 c

Temp High (0.0 c)
1c to 44.0 c

Temp Change (0.01%)
0.00 to 9.9%

Relay (Disabled)

Feed Smart Timer (Disabled)

Instrument (Instrument)

Device Address
Local Machine
Master
Slave 1-31

Relay (Unassigned)
Relay 1-8

Units (oz)
oz
g
lb
kg

Calibrate (180) (0 oz)

Feed Timer Test Run Time

Feed Timer Test Weight

Appendix 4 - Declaration of Conformity

The undersigned hereby declares on behalf of the named manufacturer under our sole responsibility that the listed product conforms to the requirements for the listed European Council Directive(s) and carries the CE mark accordingly.

<i>Manufacturer:</i>	YSI Incorporated 1725 Brannum Lane Yellow Springs, OH 45387 USA
<i>Product Name:</i>	5400, 5500D-01, 5500D-02, 5500D-04
<i>Model Numbers</i>	
<i>Instrument/Accessory:</i>	5400, 5500D-01, 5500D-02, 5500D-04
<i>Conforms to the following:</i>	
<i>Directives:</i>	EMC 2004/108/EC RoHS 2011/65/EU WEEE 2002/96/EC LVD 2006/95/EC
<i>Harmonized Standards:</i>	<ul style="list-style-type: none"> • EN61326-1:2006, Electrical equipment for measurement, control, and laboratory use – EMC requirements – Part 1: General Requirements • EN61326-2-3:2006, Electrical equipment for measurement, control and laboratory use – EMC requirements – Part 2-3: Particular Requirements – Test configuration, operational conditions, and performance criteria for transducers with integrated or remote signal conditioning. • EN61000-3-2:2006+A1:2009+A2:2009, Electromagnetic compatibility (EMC) – Part 3-2: Limits – Limits for harmonic current emissions (equipment input current < 16A per phase). • EN61000-3-3:2008, Electromagnetic compatibility (EMC) – Part 3-3: Limits – Limitation of voltage changes, voltage fluctuations and flicker in public low-voltage supply systems, for equipment with rated current < 16A per phase and not subject to conditional connection.. • IEC61010-1:2010

<i>Supplementary Information:</i>	All performance met the continuous unmonitored operation criteria as follows: <ul style="list-style-type: none"> • ESD, EN61000-4-2:2008 2nd edition • Radiated Immunity, EN61000-4-3:2006+A1:2007 3rd edition. • EFT, EN61000-4-4:2004 2nd edition, (EFT). • Surge, EN61000-4-5:2005 2nd edition • Conducted Immunity, EN61000-4-6:2008 3rd edition • Voltage Interrupts, EN61000-4-11:2004 2nd edition • EN61000-4-8:2001 1st edition Power frequency magnetic field immunity
<i>Authorized EU Representative</i>	YSI Hydrodata Ltd Unit 8, Business Centre West, Avenue 1 Letchworth, Hertfordshire, SG6 2HB UK



Signed: Lisa M. Abel
Title: Director of Quality

Date: 24 July 2011

The undersigned hereby declares on behalf of the named manufacturer under our sole responsibility that the listed product conforms to the requirements for electrical equipment under US FCC Part 15 and ICES-003 for unintentional radiators.

<i>Manufacturer:</i>	YSI Incorporated 1725 Brannum Lane Yellow Springs, OH 45387 USA
<i>Product Name:</i>	5400, 5500D-01, 5500D-02, 5500D-04
<i>Model Numbers</i>	
<i>Instrument/Accessory:</i>	5400, 5500D-01, 5500D-02, 5500D-04
<i>Conforms to the following:</i>	
<i>Standards:</i>	<ul style="list-style-type: none"> • FCC 47 CFR Part 15-2008, Radio Frequency Devices • ICES-003:2004, Digital Apparatus
<i>Supplementary Information:</i>	Tested using ANSI C63.4-2003 and CAN/CSA-CEI/IEC CISPR 22:02



Signed: Lisa M. Abel
Title: Director of Quality

Date: 24 July 2011

The undersigned hereby declares on behalf of the named manufacturer under our sole responsibility that the listed product conforms with the Australian and New Zealand Electromagnetic Compatibility (EMC) requirements for generic products to be used in residential, commercial, and light industrial environments.

<i>Manufacturer:</i>	YSI Incorporated 1725 Brannum Lane Yellow Springs, OH 45387 USA
<i>Product Name:</i>	5400, 5500D-01, 5500D-02, 5500D-04
<i>Model Numbers</i>	
<i>Instrument/Accessory:</i>	5400, 5500D-01, 5500D-02, 5500D-04
<i>Conforms to the following:</i>	
<i>Standards:</i>	<ul style="list-style-type: none"> • AS/NZS 61000.6.3:2007+A1:2009 Electromagnetic compatibility (EMC), Part 6-3-Emission • AS/NZC 61000.3.2:2007+A1:2009 EMC, Limits for harmonic current emissions • AS/NZS 61000.3.3:2006, Limitation of voltage changes, voltage fluctuations and flicker in public low-voltage supply systems • AS/NZC 61000.6.1:2006 EMC Part 6-1. Immunity.



Signed: Lisa M. Abel
Title: Director of Quality

Date: 24 July 2011

FCC Required Notice

The Federal Communications Commission defines this product as a computing device and requires the following notice.

This equipment generates and uses radio frequency energy and if not installed and used properly, may cause interference to radio and television reception. It has been type tested and found to comply with the limits for a Class A or Class B computing device in accordance with the specification in Subpart J of Part 15 of FCC Rules, which are designed to provide reasonable protection against such interference in a residential installation. However, there is no guarantee that interference will not occur in a particular installation. If this equipment does cause interference to radio or television reception, which can be determined by turning the equipment off and on, the user is encouraged to try to correct the interference by one or more of the following measures:

- Reorient the receiving antenna
- Relocate the computer with respect to the receiver
- Move the computer away from the receiver
- Plug the computer into a different outlet so that the computer and receiver are on different branch circuits.

If necessary, the user should consult the dealer or an experienced radio/television technician for additional suggestions. The user may find the following booklet, prepared by the Federal Communications Commission, helpful: "How to Identify and Resolve Radio-TV Interference Problems". This booklet is available from the U.S. Government Printing Office, Washington, D.C. 20402, Stock No.0004-000-00345-4.

Appendix 5 Parts and Accessories

Replacement Part	Part Number and Description
Galvanic probe/cable assemblies cable lengths available: 4m, 10m, 20m, 30m, and custom to 100 m	
	p/n 5420-X (X=cable length; galvanic DO probe cable assembly) p/n 5421-X (X=cable length; galvanic and temperature probe cable assembly)
DO Membranes for Galvanic DO Sensor	
2 mil Teflon	5405-5 membrane kit contains: -5 membrane -electrolyte solution
2 mil Teflon	5405-25 membrane kit contains: -25 membranes -electrolyte solution
Electrolyte solution	5406, 1 pint
DO Membranes and electrolyte solution for Polarographic sensor	
2 mil PE (blue)	605307 membrane kit contains: -6 cap membranes -electrolyte solution -sanding disk -3 gaskets
2 mil Teflon (gray)	605204 membrane kit contains: -6 cap membranes -Probe electrolyte -sanding disk -3 gaskets
ODO probe/cable assemblies and replacement sensor cap cable lengths available: 1m, 4m, 10m, 20m, 30m, and custom to 100 m	
	626250-X (X=cable length; ODO probe cable assembly)
	626320 Replacement Sensor Cap
Installation Mounting kits	
Panel mount kit	006510 - for mounting 5200A instrument to a panel.
Rail mount kit	006509 - for mounting a 5200A instrument to a rail.
Weather shield kit	006505

Replacement Part	Part Number and Description
Other	
AC Power cord, 115 VAC, USA plug	605880, for AC version only, included with AC version
Adapter, DB-9 to RJ-45	655383, included with instrument
AquaManager Software, single and network use	655363
Compression Plugs, Large	605230, 2 each included with instrument
Compression Plugs, Large	605229, 2 each included with instrument
Compression Plugs, Medium	605898, 3 each included with instrument
Compression Plugs, Small	605804, 4 each included with instrument
Conduit fittings	065926UL - For optional conduit mount, industrial encapsulant required
Conduit Sealer	065921, industrial encapsulant require for above item
Desiccant pack replacement	006506, included with instrument
DO (Galvanic) sensor reconditioning kit	5407
Dual Male, RJ-45 Cable Assembly	655384, included with instrument
Flange Mounting Kit	006515, included with instrument
Grounding Screws	605889, included with instrument
Pluggable Socket Connector for AC power, 3 pole	605944UL, for AC version only, included with AC version
Pluggable Socket Connector for Auxiliary Inputs, 3 pole	605940UL, included with instrument
Pluggable Socket Connector for Aux and DO inputs, 8 pole	605942UL, included with instrument
Pluggable Socket Connector for relays, 12 pole	605943UL, 2 each included with instrument
Pluggable Socket Connector for RS-485, 5 pole	605941UL, included with instrument
Pluggable Socket Connector for 12 VDC power, 2 pole	506939UL, included with instrument
RS-232 Opto Isolator, DB-9 to RJ-45	605285
Serial to Ethernet device kit	5402
User Manual	605878, included with instrument

Replacement Part	Part Number and Description
12-volt power supply, 115 VAC input	605227UL
12-volt power supply, 230 VAC input	655478UL
230 VAC power cord, European (AC version only)	606100
230 VAC power cord, UK (AC version only)	606101
230 VAC power cord, Australia (AC version only)	606102
USB to Serial PC adapter	YSI part number #773

Appendix 6 - SMS messaging

SMS (Short Message Service) or text messaging is a service for sending messages to your Cell phone or Pager (mobile device). Using the optional xPort Ethernet solution, you can redirect your alarm messages to your mobile device.

Under the Service->Communications->Ethernet menu you will find a menu item called Email Address. Using the format from your carrier, see list below, replace your email address with this information. Example: Your Cell phone number is 858-555-1212 and your carrier is Sprint PCS, your email address would be 8585551212@messaging.sprintpcs.com. Note the maximum size of your email address or cell phone information is 49 characters. This should be large enough to cover most email addresses.

Below is a list of major USA Cellular and Pager companies that support sending Text messages to a Cell Phone or pager device via email (xPort Ethernet solution). If your carrier is international or is not listed here, please visit <http://www.notepage.net/sntp.htm> for a more comprehensive list or contact your service provider for information on how to send a SMS or Email message to your mobile device.

<u>Company Name</u>	<u>SMTP Format</u>
Alltel	[10-digit phone number]@message.alltel.com
AT&T	[10-digit phone number]@txt.att.net
Boost	[10-digit phone number]@myboostmobile.com
Nextel	[10-digit telephone number]@messaging.nextel.com
Sprint PCS	[10-digit phone number]@messaging.sprintpcs.com
T-Mobile	[10-digit phone number]@tmomail.net
US Cellular	[10-digit phone number]@email.uscc.net (SMS)
Verizon	[10-digit phone number]@vtext.com
Virgin Mobile USA	[10-digit phone number]@vmobl.com

data current as of April 2, 2012 @<http://www.notepage.net/sntp.htm>

Appendix 7 - Alpha "A" curve

ALPHA "A" CURVE
Resistance-Temperature Conversion Table

Temp °C	Resistance	Temp °C	Resistance	Temp °C	Resistance	Temp °C	Resistance
-40	336600.0000	8	21920.0000	56	2878.00000	104	605.000000
-39	315000.0000	9	20880.0000	57	2774.00000	105	588.000000
-38	295000.0000	10	19900.0000	58	2674.00000	106	571.400000
-37	276400.0000	11	18970.0000	59	2580.00000	107	555.600000
-36	259000.0000	12	18090.0000	60	2488.00000	108	540.200000
-35	242800.0000	13	17260.0000	61	2400.00000	109	525.200000
-34	227800.0000	14	16460.0000	62	2316.00000	110	510.800000
-33	213800.0000	15	15710.0000	63	2234.00000	111	496.800000
-32	200600.0000	16	15000.0000	64	2158.00000	112	483.200000
-31	188400.0000	17	14320.0000	65	2082.00000	113	470.200000
-30	177000.0000	18	13680.0000	66	2012.00000	114	457.400000
-29	166400.0000	19	13070.0000	67	1942.00000	115	445.200000
-28	156500.0000	20	12490.0000	68	1876.00000	116	433.400000
-27	147200.0000	21	11940.0000	69	1813.00000	117	421.800000
-26	138500.0000	22	11420.0000	70	1751.00000	118	410.600000
-25	130400.0000	23	10920.0000	71	1693.00000	119	399.800000
-24	122900.0000	24	10450.0000	72	1637.00000	120	389.400000
-23	115800.0000	25	10000.0000	73	1582.00000	121	379.200000
-22	109100.0000	26	9574.00000	74	1530.00000	122	369.400000
-21	102900.0000	27	9166.00000	75	1480.00000	123	359.800000
-20	97120.0000	28	8778.00000	76	1432.00000	124	350.600000
-19	91660.0000	29	8408.00000	77	1385.00000	125	341.600000
-18	86540.0000	30	8058.00000	78	1341.00000	126	332.800000
-17	81720.0000	31	7722.00000	79	1298.00000	127	324.400000
-16	77220.0000	32	7404.00000	80	1256.00000	128	316.200000
-15	72980.0000	33	7098.00000	81	1216.00000	129	308.200000
-14	69000.0000	34	6808.00000	82	1178.00000	130	300.600000
-13	65260.0000	35	6532.00000	83	1141.00000	131	293.000000
-12	61760.0000	36	6268.00000	84	1105.00000	132	285.800000
-11	58460.0000	37	6016.00000	85	1071.00000	133	278.800000
-10	55340.0000	38	5776.00000	86	1038.00000	134	272.000000
-9	52420.0000	39	5546.00000	87	1006.00000	135	265.200000
-8	49660.0000	40	5326.00000	88	975.000000	136	258.800000
-7	47080.0000	41	5118.00000	89	945.200000	137	252.600000
-6	44640.0000	42	4918.00000	90	916.400000	138	246.400000
-5	42340.0000	43	4726.00000	91	888.800000	139	240.600000
-4	40160.0000	44	4544.00000	92	862.000000	140	234.800000
-3	38120.0000	45	4368.00000	93	836.400000	141	229.200000
-2	36200.0000	46	4202.00000	94	811.400000	142	223.800000
-1	34380.0000	47	4042.00000	95	787.400000	143	218.400000
0	32660.0000	48	3888.00000	96	764.200000	144	213.400000
1	31040.0000	49	3742.00000	97	741.800000	145	208.400000
2	29500.0000	50	3602.00000	98	720.200000	146	203.600000
3	28060.0000	51	3468.00000	99	699.400000	147	198.800000
4	26680.0000	52	3340.00000	100	679.200000	148	194.200000
5	25400.0000	53	3216.00000	101	659.600000	149	189.700000
6	24180.0000	54	3098.00000	102	640.800000	150	185.400000
7	23020.0000	55	2986.00000	103	622.600000		

Appendix 8 - Warranty

The YSI 5X00 instrument is warranted by YSI for two years from date of purchase by the end user against defects in materials and workmanship (excluding components and materials for the YSI 5X00 which are separately warranted below). All YSI cables, probe modules, and sensors for the YSI 5X00 are warranted by YSI for one year from date of purchase by the end user against defects in material and workmanship. Within the applicable warranty period, YSI will repair or replace, at its sole discretion, free of charge, any product that YSI determines to be covered by this warranty.

To exercise this warranty, call your local YSI representative, or contact YSI customer service in Yellow Springs, Ohio at +1 937 767-7241. Send the product and proof of purchase, transportation prepaid, to the Authorized Service Center selected by YSI. Repair or replacement will be made and the product returned, transportation prepaid. Repaired or replaced products are warranted for the balance of the original warranty period, or at least 90 days from date of repair or replacement. The end user making a claim under any of these warranties is responsible for all product removal and reinstallation costs related to any product repair or replacement under any such warranty.

Limitation of Warranty

This warranty does not apply to any YSI product damage or failure caused by:

1. failure to install, operate or use the product in accordance with YSI's written instructions;
2. abuse or misuse of the product;
3. failure to maintain the product in accordance with YSI's written instructions or standard industry procedure;
4. any improper, incorrect or substandard repairs to the product not performed by YSI;
5. use by anyone (other than YSI) of any defective or improper component or part in servicing or repairing the product;
6. modification of the product in any way not expressly authorized by YSI.

THIS WARRANTY IS IN LIEU OF ALL OTHER WARRANTIES, EXPRESSED OR IMPLIED, INCLUDING ANY WARRANTY OF MERCHANTABILITY OR FITNESS FOR A PARTICULAR PURPOSE. YSI'S LIABILITY UNDER THIS WARRANTY IS LIMITED TO REPAIR OR REPLACEMENT OF THE PRODUCT, AND THIS SHALL BE THE SOLE AND EXCLUSIVE REMEDY FOR ANY DEFECTIVE PRODUCT COVERED BY THIS WARRANTY. IN NO EVENT SHALL YSI BE LIABLE FOR ANY SPECIAL, INDIRECT, INCIDENTAL OR CONSEQUENTIAL DAMAGES RESULTING FROM OR CAUSED BY ANY DEFECTIVE PRODUCT COVERED BY THIS WARRANTY.

Appendix 9 - Contact Us

Ordering and Technical Support

Please visit www.yisi.com for a list of YSI's locations worldwide along with additional contact information.

YSI, Inc. Corporate Headquarters:

Telephone: 800 897 4151 (US)
+1 937 767 7241 (Globally)
Monday through Friday, 8:00 AM to 5:00 ET

Fax: +1 937 767 9353 (orders)
+1 937 767 1058 (technical support)

Email: environmental@ysi.com

Mail: YSI Incorporated
1725 Brannum Lane
Yellow Springs, OH 45387 USA

Web Site: www.yisi.com

When placing an order please have the following available:

- 1.) YSI account number (if available)
- 2.) Name and phone number
- 3.) Purchase Order or Credit Card
- 4.) Model Number or brief description
- 5.) Billing and shipping addresses
- 6.) Quantity

Service Information

YSI has authorized service centers throughout the United States and Internationally. For the nearest service center information, please visit www.yisi.com and click 'Support' or contact YSI Technical Support directly at +1 937-767-7241.

When returning a product for service, include the Product Return form with cleaning certification. The form must be completely filled out for a YSI Service Center to accept the instrument for service. The form may be downloaded from www.yisi.com by clicking on the 'Support' tab, then the Product Return Form button..

Appendix 10 - Recycling

Recycling

YSI is committed to reducing the environmental footprint in the course of doing business. Even though materials reduction is the ultimate goal, we know there must be a concerted effort to responsibly deal with materials after they've served a long, productive life-cycle. YSI's recycling program ensures that old equipment is processed in an environmentally friendly way, reducing the amount of material going to landfills.

- Printed Circuit Boards are sent to facilities that process and reclaim as much material for recycling as possible.
- Plastics enter a material recycling process and are not incinerated or sent to landfills.
- Batteries are removed and sent to battery recyclers for dedicated metals.

When the time comes for you to recycle, follow the easy steps outlined at www.yisi.com.

Battery Disposal

The circuit board in this instrument contains a manganese dioxide lithium "coin cell" battery that must be in place for continuity of power to memory devices on the board. This battery is not user serviceable or replaceable. When appropriate, an authorized YSI service center will remove this battery and properly dispose of it, per service and repair policies

Index

Symbols

- 5X00
 - meaning & usage 10, 12
- 30 second power up delay 75, 152
- 30 second sensor system hold off 159, 160

A

- Adjust contrast menu 87
- Alarms
 - alarm hold off 132
 - alarm value 156
 - general alarm 131
- AquaManager 197
 - and data logging 118, 121, 204
 - and sensor setup menu 179
 - and system menu 149
 - and timer menu 190
 - autopoller 204
 - alarm emails 206
 - mapping 205
 - database management 204
 - installation 198
 - PC requirements 198
 - Windows 200
 - explorer window 200
 - node (graph) window 202
 - systems management 203
- Autofix 157
- Auxiliary (Aux) systems
 - configure 101
 - display format 105, 114
 - input type 103, 110, 111
 - analog (non temperature) 104
 - analog (temperature) 107
 - digital 103
 - min/max values 104, 114

- probe name 102
- suffix 104, 113
- control/alarm low and high. *See* sensor setup analog (aux non temperature)
- control/alarm on open or closed. *See* sensor setup (aux) digital
- input scaling 105, 114
- sensor setup (non temperature)
 - analog (non temperature) 166
 - hold off 164
 - relay 166, 177
- sensor setup (temperature) 168
- wiring
 - analog (non temperature) 59
 - digital 59
 - temperature sensor 52

B

- Backlight timer menu 89
- Baud rate (RS232) 100
- Biomass (feed timer) 186
- Bulkhead fittings 40
 - rubber grommets 40
- Buzzer menu 89

C

- Calibration
 - calibration menu 81
 - DO mg/l 84
 - DO % sat 83
 - feed timer 189
 - getting ready to calibrate DO sensor 82
 - log 83
 - sensors
 - “check probe” 82
- Chiller hold off time (temperature control high) 157
- Circuit Boards. *See* PCBs
- Clean probe timer 140
- Clear Logs 121
- Communication hardware wiring 66

Communication menu 89
 email alarming 90
 email retry delay 100
 ethernet 92
 SMS messaging 96
 force serial port 101
 Network 96
 RS232 baud rate 100
 send test email 99
Configuration log 118
configure E-Aux system menu 108
contactor. *See* Wiring contactor
Contact Us 258
Control board 42
Control menu 192
control modes 152, 153
Control modes
 PID/PWM control mode 159, 160
 PID/PWM Tuning 163
 set point control mode 153

D

Daily feedings (Feed Smart timer) 185
Daily weight (Feed Smart timer fcr) 186
Daily weight (Feed Smart timer-non fcr) 185
Data Logging menu
 clear logs 121
 event log 120
 sensor log (data log) 118
Date and Time menu 122
Declaration of conformity 248
Defaults. *See* Factory defaults
device time out error. *See* Firmware Updater
DHCP (ethernet menu) 93
Display format (analog aux non temperature) 105, 114
Display Settings menu 123
DNS address (ethernet menu) 95
DO sensor calibration mg/l 84
DO sensor calibration % sat 83
DO sensor setup 173

E

E-Aux
 Offline 173
Email addresses (ethernet menu) 95
Email alarming 90
 5400 email 90
 AquaManager email 90
 email retry delay 100
 send test email 99
Ethernet menu 92
 DHCP 93
 DNS address 95
 email addresses 95
 gateway 94
 IP address 93
 port 95
 subnet mask 94
Ethernet module
 configure communications ethernet menu 92
 installation 68
 SMS messaging 96
Event logging 120
Event log view 194
Explorer window - AquaManager 200

F

Factory defaults 225
fcr (feed timer) 186
Feed Smart Timer
 biomass 186
 calibrate 189
 daily feedings 185
 daily weight 186
 fcr
 biomass 186
 daily weight 186
 fcr factor 187
 feed % biomass 186

- feed mode
 - continuous 184
 - timed 184
- sensors 187
 - DO and temperature low/high % change 188
- Firmware Updater
 - could not find unit error 130
 - device timed out error 130
 - force downloader 130
 - Unit is Up-To-Date message 130
- Force serial port (communications menu) 101
- Front panel
 - keys 73
 - open 41
 - run screen 75
 - softkeys 73
- G**
- Gateway (ethernet menu) 94
- General Alarm menu 131
 - hold off 132
 - relay 132
- Grounding
 - 5400 43
 - tanks 43
- H**
- Hardware
 - bulkhead fittings 40
 - ethernet module 68
 - installation and wiring chapter 25
 - lower board assembly 42
 - PCBs 39
- I**
- Icons 76
- input scaling (aux systems) 105, 114
- Input type (aux) 103, 110, 111
- Installation 26–35. *See also* Wiring
 - 5400 location considerations 27

- Installation and wiring chapter 25
- mounting 5400
 - panel 29
 - rail 29
 - surface 28
 - weather shield 33
- qualified installer 12, 21
- sensors
 - DO 5420 & 5421 galvanic 37
 - DO 5422 polarographic 37
 - location considerations 35
 - temperature 38
 - system schematic (sample) 26
- instrument and relay name conventions 136
- I/O Board 39
 - accessing 40
- IOEM/REM. *See* IOEM/REM-see IOEM/REM safety and installation guide for wiring and configuration info
- IOEM/REM installation 68
- IP address (ethernet menu) 93
- K**
- keys. *See* Front panel
- L**
- Lanyard 31, 40
- Lightning and Surge Protection 68
- local versus remote machine 86
- Logs
 - calibration 83
 - clear logs 121
 - configuration log 118
 - event log 120
 - sensor log (data log) 118
- M**
- Maintenance
 - AquaManager database maintenance 216
 - DC batteries 216

Menus

- Calibration 81
 - DO
 - mg/l 84
 - %sat 83
- Control 192
- Hierarchy 78
- Menu maps 225
 - menu map key 226
- Msg's menu 193
- Sensor setup 150
 - Aux
 - analog 0-1V, 0-5V, 4/20ma 166
 - temperature 168
 - DO 173
- Service hold menu 196
- Submenu screen types
 - alpha/numeric 80
 - numeric 80
 - pull-down 80
- Systems menu 86–125
 - adjust contrast 87
 - backlight timer 89
 - buzzer 89
 - communication 89
 - email alarming 90
 - ethernet 92
 - network 96
 - configure aux 101
 - input type 103, 110, 111
 - name 102
 - data logging
 - clear logs 121
 - data log (sensor log) 118
 - event logging 120
 - date/time 122
 - display settings 123
 - general alarm 131
 - name devices/sensors 134
 - password 137

- serial number 139
- service 140
- service hold (enable and hold off) 147
- version 148
- Timers menu
 - Feed Smart timer 182
 - Timers 1-4 (10 daily event) 180
- Min/max values (analog aux non temperature) 104, 114
- mounting 5400. *See* Installation

N

- Name devices/sensors menu 134
- Network
 - node network (master/slave) 96
 - non-networked 5400s 101
 - termination relay 99
 - wiring
 - loops 64
 - stars 64
 - stub 60, 63

O

“over”. *See* sensors “over” and “under” values

P

- Panel mount 5400 29
- Password menu 137
- PCBs (printed circuit boards) 39
- Port (ethernet menu) 95
- Power (wire) 45
 - AC 45
 - DC and backup 46
 - specifications 16
 - view current power 148
- Probes
 - calibration 81
 - DO 5420 and 5421 galvanic 37
 - DO 5422 polarographic DO/temperature 37
 - locate and install 34

name probe (sensor) system 134
 probe (sensor) setup. *See* Sensor setup menu

R

Rail mount 5400 29
 Recycling 259
 Relays
 wiring 54
 wiring a contactor 55
 Remote versus local machine 86
 REM *see* OEM/REM. *See* OEM/REM
 Reset to factory
 reset all 142
 reset clean probe timer 140
 reset sensors 143
 reset system(s) 142
 reset timers 143
 RS232
 PC connection 66
 rubber grommets. *See* Bulkhead fittings
 Run Screen 75
 run screen icons 76

S

Safety
 cautions 23
 warnings 21
 Sensor (data) log
 view 195
 Sensor log setup. *See* Data Logging menu
 Sensors
 and Feed Smart timer 187
 “check probe” 82
 name 134
 “over” and “under” values 152
 wire 49
 DO sensors 49
 temperature sensors 52
 Sensor setup menu 150
 30 second sensor system hold off 159, 160
 aux (non temperature)

analog 166
 digital
 relay 164
 relay 166, 177
 aux (temperature) 168
 control mode 152
 DO 173
 set points, controls, alarms 152
 Serial number 139
 Service hold 196
 configure service hold 147
 Service menu 140. *See also* Reset to factory
 Set point value 153
 SMS messaging 96
 SMS messaging formats 255
 Softkeys 74
 Specifications
 environmental 14
 inputs
 aux (non temperature) 14
 DO 14
 temperature 15
 systems (non input)
 AquaManager 17
 communication 17
 ethernet module 17
 RS232 17
 firmware 16
 hardware 16
 power 16
 Stub (network wiring) 60, 63
 Submenu screen types 80
 Subnet mask (ethernet menu) 94
 Suffix (analog non temperature) 104, 113
 Surface mount 5400 28
 Surge and lightning protection 68
 Systemwide event 120

T

Technical Support 258
 Temperature 168

- aux input (configure input type) 107
- temperature conversion table Alpha “A” curve 256
- Termination relay
 - and networks 99
 - and non-networked 5400s 101
- test outputs 144
- Timers 180
 - clean probe timer 140
 - daily 10 event timers (4) 180
 - Feed Smart timer 182
 - calibrate feeder 189
 - daily feedings 185
 - daily weight 186
 - fcr 186
 - biomass 186
 - daily weight 186
 - feed % biomass 186
 - feed mode
 - continuous 184
 - timed 184
 - sensors 187
- Troubleshooting 219–225
 - AquaManager 224
 - email alarming 221
 - Feed Smart timer 224
 - firmware updater 223
 - network 222
 - other 5400 systems 222
 - relays 220
 - sensors 219

U

- “under”. *See* Sensors “over” and “under” values
- Unpacking and inspection 218
- use AquaManager to configure inputs and outputs 150

V

- Validation error 157
- Version (firmware) 148

W

- Warranty 257
- Weather shield 33
- Wiring 39–59
 - accessing I/O board 40
 - aux (non temperature) 56
 - analog instrument 59
 - digital instrument 59
 - bulkhead fittings 40
 - communication equipment 66
 - ethernet module 68
 - rs232 66
 - contactor 55
 - control board 42
 - grounding 5400 43
 - PCBs 39
 - power 45
 - AC 45
 - DC and backup power 46
 - relay outputs 54
 - sensor 49
 - DO 49
 - temperature 52

Item # 605877
Rev F
Drawing # A605877
May 2015
Copyright
©2015 YSI Incorporated.